

1.30.496



1.30.497



1.30.498



VALORES DE CONEXIÓN · VALEURS DE BRANCHEMENT · ANSCHLUSSWERTE
 WAARDEN VAN DE VERBINDING · VALORI DI CONNESSIONE · NASTAVENÍ PŘIPOJENÍ
 FITTING CONNECTION SPECIFICATIONS · CHARAKTERYSTYKI PODŁĄCZENIA
 CONDIÇÕES DE CONEXÃO · ПРОМЫВКА СИСТЕМЫ



Min.
1 Bar

Max.
5 Bar



1 - 5 Bar



<1 >5



Max.
80° C

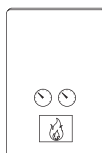

65° C
50° C

Ok



80° C

INSTALACIÓN · INSTALLATION · INSTALLATION · INSTALLATIE · INSTALLAZIONE
 INSTALACE · INSTALLATION · MONTAŽ · INSTALAÇÃO · УСТАНОВКА

1.30.496

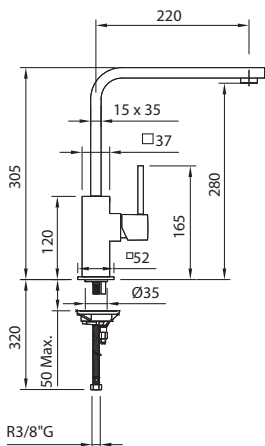

1.30.497

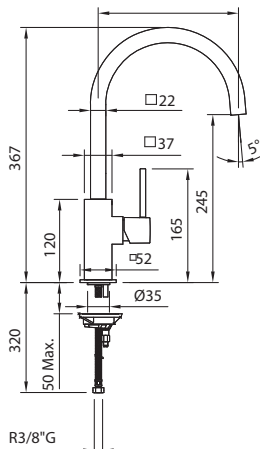

1.30.498

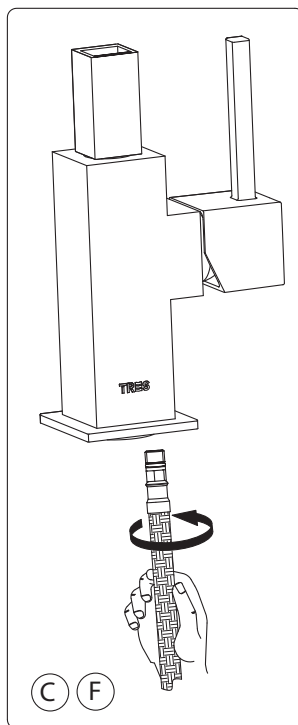
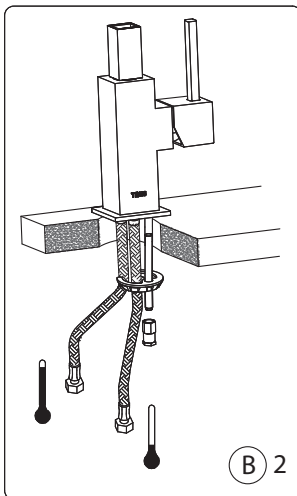
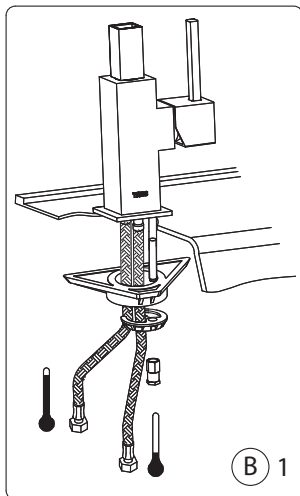
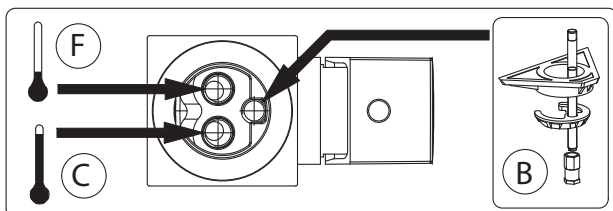
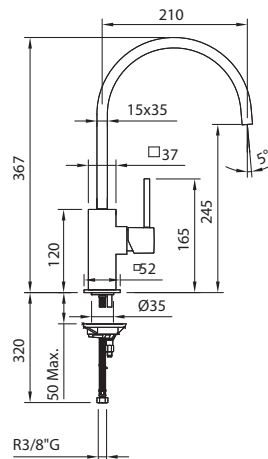

PURGAR INSTALACIÓN · PURGER L'INSTALLATION · WASSER AUS DEN ROHREN ABLASSEN
 DE INSTALLATIE ONTLUCHTEN · SPURGARE L'IMPIANTO · NECHTE Z POTRUBÍ VYTĚCT VEŠKEROU VODU
 BLEEDING THE EQUIPMENT · ODPROWADZIĆ WODĘ Z INSTALACJI
 PURGAR A INSTALAÇÃO · ПРОМЫВКА СИСТЕМЫ

1.30.498

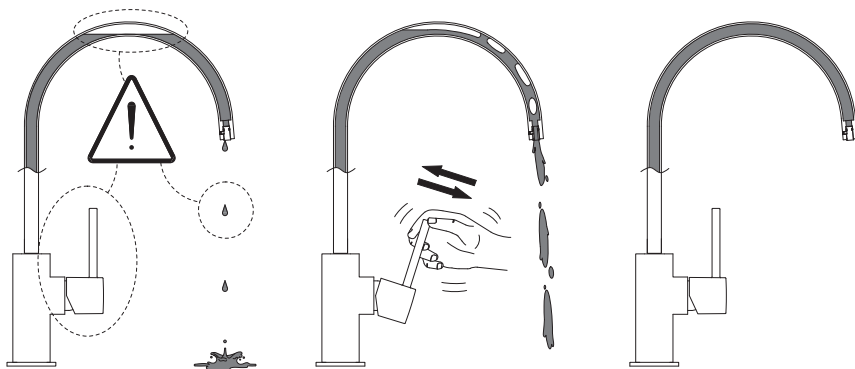

INSTRUCCIONES DE MANTENIMIENTO · INSTRUCTIONS POUR L'ENTRETIEN
 WARTUNGSANLEITUNG · ONDERHOUDSAANWIJZINGEN · ISTRUZIONI PER LA MANUTENZIONE
 POKYNY K ÚDRŽBĚ · MAINTENANCE INSTRUCTIONS · INSTRUKCJA KONSERWACJI
 INSTRUÇÕES DE MANUTENÇÃO · ИНСТРУКЦИИ ПО УХОДУ

1.30.496

1.30.497

1.30.498

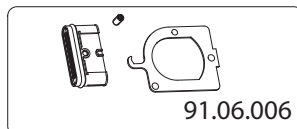
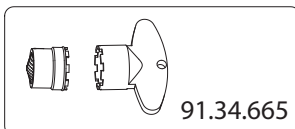
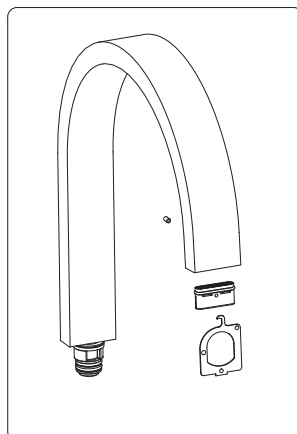
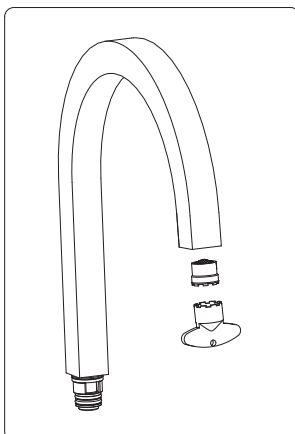
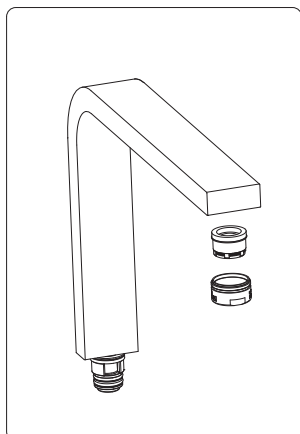

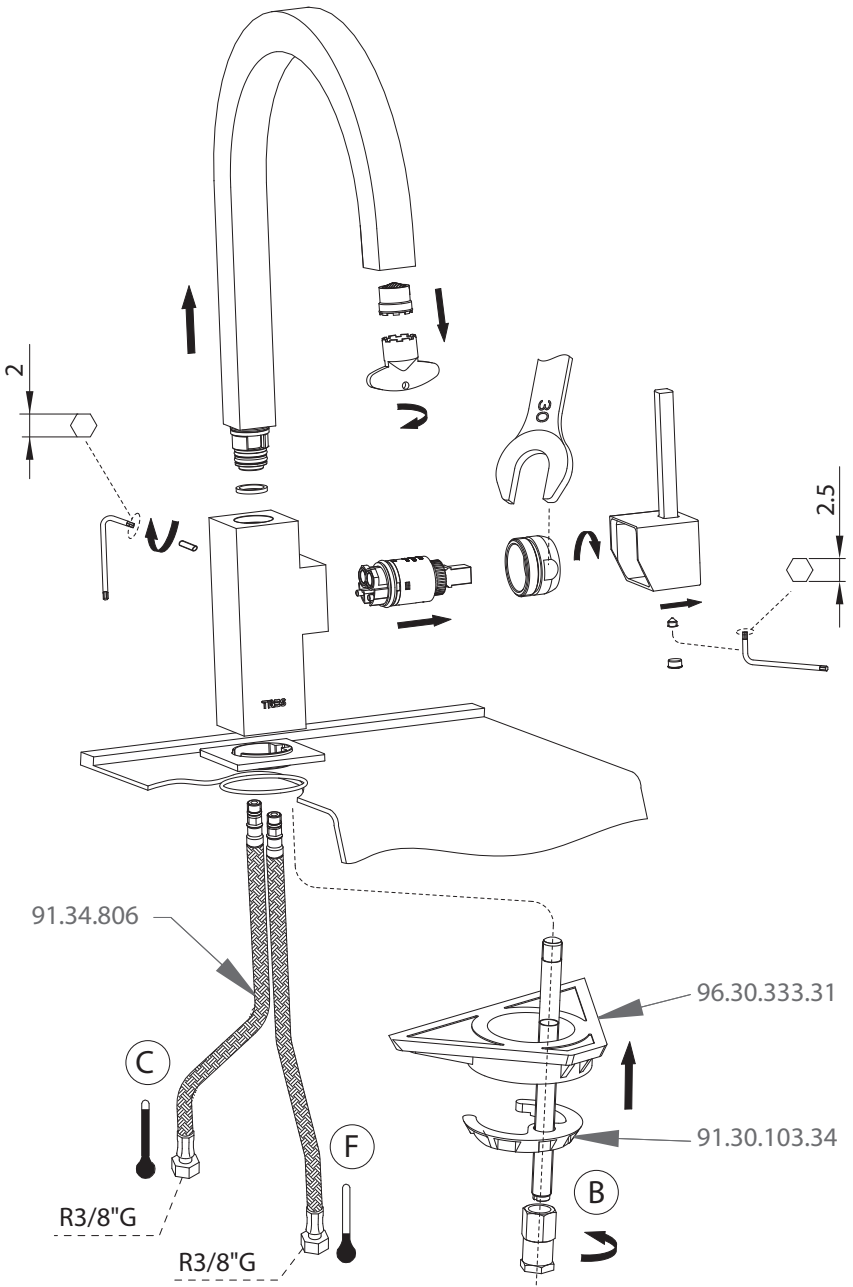

TRES

TRES COMERCIAL, S.A.
 Calle Penedés, 26
 Zona Industrial, Sector A
 08759 VALLIRANA (Barcelona)

Tel. (34) 936 83 40 04
 Fax (34) 936 83 02 23
 comercialtres@tresgriferia.com
 www.tresgriferia.com