

<b>DE</b>	Gebrauchsanleitung / Montageanleitung	<b>2</b>
<b>FR</b>	Mode d'emploi / Instructions de montage	<b>3</b>
<b>EN</b>	Instructions for use / assembly instructions	<b>4</b>
<b>IT</b>	Istruzioni per l'uso / Istruzioni per Installazione	<b>5</b>
<b>ES</b>	Modo de empleo / Instrucciones de montaje	<b>6</b>
<b>NL</b>	Gebruiksaanwijzing / Handleiding	<b>7</b>
<b>DK</b>	Brugsanvisning / Monteringsvejledning	<b>8</b>
<b>PT</b>	Instruções para uso / Manual de Instalação	<b>9</b>
<b>PL</b>	Instrukcja obsługi / Instrukcja montażu	<b>10</b>
<b>CS</b>	Návod k použití / Montážní návod	<b>11</b>
<b>SK</b>	Návod na použitie / Montážny návod	<b>12</b>
<b>ZH</b>	用户手册 / 组装说明	<b>13</b>
<b>RU</b>	Руководство пользователя / Инструкция по монтажу	<b>14</b>
<b>HU</b>	Használati útmutató / Szerelési útmutató	<b>15</b>
<b>FI</b>	Käyttöohje / Asennusohje	<b>16</b>
<b>SV</b>	Bruksanvisning / Monteringsanvisning	<b>17</b>
<b>LT</b>	Vartotojo instrukcija / Montavimo instrukcijos	<b>18</b>
<b>HR</b>	Upute za uporabu / Uputstva za instalaciju	<b>19</b>
<b>TR</b>	Kullanım kılavuzu / Montaj kılavuzu	<b>20</b>
<b>RO</b>	Manual de utilizare / Instrucțiuni de montare	<b>21</b>
<b>EL</b>	Οδηγίες χρήσης / Οδηγία συναρμολόγησης	<b>22</b>
<b>SL</b>	Navodilo za uporabo / Navodila za montažo	<b>23</b>
<b>ET</b>	Kasutusjuhend / Paigaldusjuhend	<b>24</b>
<b>LV</b>	Lietošanas pamācība / Montāžas instrukcija	<b>25</b>
<b>SR</b>	Uputstvo za upotrebu / Uputstvo za montažu	<b>26</b>
<b>NO</b>	Bruksanvisning / Montasjeveiledning	<b>27</b>
<b>BG</b>	Инструкция за употреба / Инструкция за употреба	<b>28</b>
<b>SQ</b>	Udhëzuesi i përdorimit / Udhëzime rreth montimit	<b>29</b>
<b>AR</b>	دليل الاستخدام / تعليمات التجميع	<b>30</b>

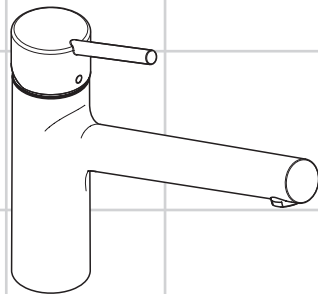

**Talis S**  
32851XXX

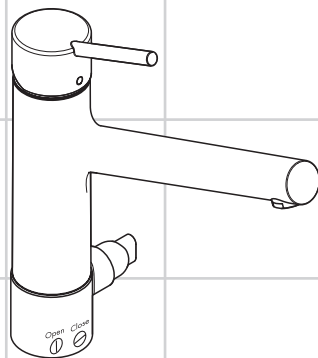

**Talis S**  
32855XXX



## Sicherheitshinweise

- ⚠ Bei der Montage müssen zur Vermeidung von Quetsch- und Schnittverletzungen Handschuhe getragen werden.
- ⚠ Große Druckunterschiede zwischen den Kalt- und Warmwasseranschlüssen müssen ausgeglichen werden.

### **32855XXX:**

- ⚠ Nur Spül- oder Waschmaschinen die das DVGW-Zeichen führen, dürfen ohne Zusatzsicherung an das Geräteanschlussventil angeschlossen werden. Wird kein Verbraucher an das Geräteanschlussventil angeschlossen, muss dieses abgestopft werden.

## Montagehinweise

- Die Armatur muss nach den gültigen Normen montiert, gespült und geprüft werden!

## Technische Daten

Betriebsdruck:	max. 1 MPa
Empfohlener Betriebsdruck:	0,1 – 0,5 MPa
Prüfdruck:	1,6 MPa
(1 MPa = 10 bar = 147 PSI)	
Heißwassertemperatur:	max. 80 °C
Empfohlene Heißwassertemperatur:	65 °C

Hansgrohe Armaturen können in Verbindung mit hydraulisch und thermisch gesteuerten Durchlauferhitzern eingesetzt werden, wenn der Fließdruck mindestens 0,15 MPa beträgt.

## Symbolerklärung



Kein essigsäurehaltiges Silikon verwenden!



Einhandmischer mit Warmwasserbegrenzung, Justierung siehe Seite 32. In Verbindung mit Durchlauferhitzern ist eine Warmwassersperre nicht notwendig.



Reinigungsempfehlung siehe beiliegende Broschüre.



**Maße** (siehe Seite 33)



**Durchflussdiagramm**  
(siehe Seite 33)



**Bedienung** (siehe Seite 35)



**Serviceteile** (siehe Seite 34)

XXX = Farbcodierung  
 000 = chrom  
 800 = edelstahl-optik





**Prüfzeichen** (siehe Seite 36)



**Montage siehe Seite 31**



## Consignes de sécurité

-  Lors du montage, porter des gants de protection pour éviter toute blessure par écrasement ou coupure
-  Il est conseillé d'équilibrer les pressions de l'eau chaude et froide.

### 32855XXX:

-  Seuls les lave-vaisselle ou machines à laver portant le sigle DVGW, doivent être reliés sans fusible supplémentaire au raccord de l'appareil. Si aucun consommateur n'est relié à la valve-raccord de l'appareil, cette dernière doit être obturée.

## Instructions pour le montage

- La robinetterie doit être installée, rincée et contrôlée conformément aux normes valables!

## Informations techniques

Pression de service autorisée:	max. 1 MPa
Pression de service conseillée:	0,1 – 0,5 MPa
Pression maximum de contrôle: (1 MPa = 10 bar = 147 PSI)	1,6 MPa
Température d'eau chaude:	max. 80 °C
Température recommandée:	65 °C

Les mitigeurs Hansgrohe fonctionnent également en association à des chauffe-eau à commande hydraulique ou thermique à condition que la pression soit au minimum de 0,15 MPa.

## Description du symbole



Ne pas utiliser de silicone contenant de l'acide acétique!



Mitigeur avec limitation de la température: consulter la page 32 pour le réglage. Une limitation de la température n'est pas nécessaire quand le mitigeur est alimenté par un chauffe-eau instantané.



Pour les conseils d'entretien, voir la brochure ci-jointe.



**Dimensions** (voir page 33)



**Diagramme du débit**  
(voir page 33)



**Instructions de service**  
(voir page 35)



**Pièces détachées** (voir pages 34)

XXX = Couleurs  
000 = chromé  
800 = aspect acier inox





**Classification acoustique et débit** (voir page 36)



**Montage voir page 31**



## Safety Notes

-  Gloves should be worn during installation to prevent crushing and cutting injuries.
-  The hot and cold supplies must be of equal pressures.

### **32855XXX:**

-  Only dishwashers and washing machines certified with the DVGW emblem may be connected to the appliance connection valve without an additional fuse. If no consumer is connected to the appliance connection valve, it must be plugged.

## Installation Instructions

- The fitting must be installed, flushed and tested after the valid norms!

## Technical Data

Operating pressure:	max. 1 MPa
Recommended operating pressure:	0,1 – 0,5 MPa
Test pressure:	1,6 MPa
(1 MPa = 10 bar = 147 PSI)	
Hot water temperature:	max. 80 °C
Recommended hot water temp.:	65 °C

Hansgrohe mixers can be used together with hydraulically and thermally controlled continuous flow heaters if the flow pressure is at least 0,15 MPa.

## Symbol description



Do not use silicone containing acetic acid!



To adjust the hot water limiter on single lever mixers, please see page 32. No adjustment is necessary when using a continuous flow water heater.



Cleaning recommendations, see enclosed brochure.



**Dimensions** (see page 33)



**Flow diagram**  
(see page 33)



**Operation** (see page 35)



**Spare parts** (see page 34)

XXX = Colors  
000 = chrome plated  
800 = stainless steel optic





**Test certificate** (see page 36)



**Assembly see page 31**



## Indicazioni sulla sicurezza

-  Durante il montaggio, per evitare ferite da schiacciamento e da taglio bisogna indossare guanti protettivi.
-  Attenzione! Compensare le differenze di pressione tra i collegamenti dell'acqua fredda e dell'acqua calda.

### **3285XXX:**

-  Solo le lavastoviglie e lavatrici con il marchio DVGW si possono collegare senza fusibile supplementare con la valvola di collegamento dell'apparecchio. Nel caso in cui non si collega un apparecchio con la valvola di collegamento, la valvola deve essere chiusa con l'apposito tappo.

## Istruzioni per il montaggio

- La rubinetteria deve essere installata, pulita e testata secondo le istruzioni riportate!

## Dati tecnici

Pressione d'uso:	max. 1 MPa
Pressione d'uso consigliata:	0,1 - 0,5 MPa
Pressione di prova: (1 MPa = 10 bar = 147 PSI)	1,6 MPa
Temperatura dell'acqua calda:	max. 80 °C
Temp. dell'acqua calda consigliata:	65 °C

I miscelatori Hansgrohe possono venire usati con caldaie a „bassa pressione“ se la pressione di flusso è almeno di 0,15 MPa.

## Descrizione simbolo



Non utilizzare silicone contenente acido acetico!



Regolazione del limitatore di erogazione di acqua calda dei miscelatori monocomando, vedere pagina 32. In combinazione con le caldaie istantanee, il limitatore di erogazione di acqua calda non è necessario.



Suggerimenti per la pulizia: vedi il prospetto chiuso.



**Ingombri** (vedi pagg. 33)



**Diagramma flusso**  
(vedi pagg. 33)



**Procedura** (vedi pagg. 35)



**Parti di ricambio** (vedi pagg. 34)

XXX = Trattamento  
000 = cromato  
800 = acciaio inox acciaio



**Segno di verifica**  
(vedi pagg. 36)



**Montaggio vedi pagg. 31**



## ! Indicaciones de seguridad

- ⚠ Durante el montaje deben utilizarse guantes para evitar heridas por aplastamiento o corte.
- ⚠ Grandes diferencias de presión en servicio entre agua fría y agua caliente deben equilibrarse.

### 3285XXX:

- ⚠ Sin seguro adicional, solo está permitido conectar a la válvula de conexión de aparatos, los lavavajillas y las lavadoras que lleven incorporado el sello DVGW (Asociación alemana de especialistas en instalaciones de gas y agua). Si no se va a conectar ningún dispositivo consumidor a la válvula de conexión de aparatos, entonces esta deberá taparse con prensaestopas.

## Indicaciones para el montaje

- El grifo tiene que ser instalado, probado y testado, según las normas en vigor.

## Datos técnicos

Presión en servicio:	max. 1 MPa
Presión recomendada en servicio:	0,1 - 0,5 MPa
Presión de prueba:	1,6 MPa
(1 MPa = 10 bar = 147 PSI)	
Temperatura del agua caliente:	max. 80 °C
Temp. recomendada del agua caliente:	65 °C

Los mezcladores Hansgrohe pueden ser utilizados junto con calentadores continuos de agua que sean manejados de manera hidráulica o térmica, siempre que la presión en servicio ascienda a un mínimo de 0,15 MPa.

## Descripción de símbolos



No utilizar silicona que contiene ácido acético!



Uso como mezclador monomando con limitación del caudal de agua caliente: ver ajuste en página 32. En combinación con calentadores instantáneos no es necesario limitar el caudal de agua caliente.



Para las instrucciones de limpieza, ver el folleto adjunto.



**Dimensiones** (ver página 33)



**Diagrama de circulación** (ver página 33)



**Manejo** (ver página 35)



**Repuestos** (ver página 34)

XXX = Acabados  
000 = cromado  
800 = acero especial





**Marca de verificación** (ver página 36)





## Veiligheidsinstructies

-  Bij de montage moeten ter voorkoming van knel- en snijwonden handschoenen worden gedragen.
-  Grote drukverschillen tussen de kouden warm water-aansluitingen dienen vermeden te worden.

### **3285XXX:**

-  Enkel vaatwas- of wasmachines die beschikken over het DVGW-kenmerk, mogen zonder extra beveiliging aangesloten worden aan de aansluitklep van het apparaat. Indien geen verbruiker aan de aansluitklep van het apparaat wordt aangesloten, moet die afgesloten worden.

## Montage-instructies

- Leidingen doorspoelen volgens Norm. De mengkraan vervolgens monteren en controleren!

## Technische gegevens

Werkdruk: max.	max. 1 MPa
Aanbevolen werkdruk:	0,1 – 0,5 MPa
Getest bij:	1,6 MPa
(1 MPa = 10 bar = 147 PSI)	
Temperatuur warm water:	max. 80 °C
Aanbevolen warm water temp.:	65 °C

Hansgrohe kranen kunnen samen met hydraulisch en thermisch gestuurde geisers gebruikt worden indien de uitstroomdruk min. 0,15 MPa bedraagt.

## Symboolbeschrijving



Gebruik geen zuurhoudende silicone!



Eéngreepsmengkranen met warmwaterbegrenzing, instelling zie blz. 32. In combinatie met geisers is een warmwaterbegrenzing niet noodzakelijk.



Reinigingsadvies zie bijgevoegde brochure.



**Maten** (zie blz. 33)



**Doorstroomdiagram**  
(zie blz. 33)



**Bediening** (zie blz. 35)



**Service onderdelen** (zie blz. 34)

XXX = Kleuren  
000 = verchromd  
800 = RVS-look



**Keurmerk** (zie blz. 36)



**Montage zie blz. 31**



## Sikkerhedsanvisninger

- ⚠ Ved monteringen skal der bruges handsker for at undgå kvæstelser og snitsår.
- ⚠ Større trykforskelle mellem koldt og varmt vand bør udjævnes.

### **32855XXX:**

- ⚠ Du må kun tilslutte opvaskemaskiner og vaskemaskiner med DVGW-tegn uden ekstra sikring til apparatets tilslutningsventil. Hvis der ikke tilsluttes en forbruger til apparatets tilslutningsventil, skal ventilen lukkes med en prop.

## Monteringsanvisninger

- Ifølge gældende regler, skal armaturet monteres, skylles igennem og afprøves.

## Tekniske data

Driftstryk:	max. 1 MPa
Anbefalet driftstryk:	0,1 – 0,5 MPa
Prøvetryk:	1,6 MPa
(1 MPa = 10 bar = 147 PSI)	
Varmtvandstemperatur:	max. 80 °C
Anbefalet varmtvandstemperatur:	65 °C

Hansgrohe armaturer kan anvendes i forbindelse med hydraulisk- og termiskstyrede gennemstrømningsvandvarmere ved et vandtryk på 0,15 MPa.

## Symbolbeskrivelse



Der må ikke benyttes eddikesyreholdig silikone!



Etgrebsarmaturer med varmtvandsbegrænsning, justering se side 32. I forbindelse med gennemstrømningsvandvarmer er en varmtvandsbegrænsning ikke nødvendig.



For anbefalinger til rengøringen, se venligst den vedlagte brochure.



**Målene** (se s. 33)



**Gennemstrømningsdiagram**  
(se s. 33)



**Brugsanvisning** (se s. 35)



**Reservedele** (se s. 34)

XXX = Overflade  
000 = Krom  
800 = Stainless steel optic





**Godkendelse** (se s. 36)







## Avisos de segurança

-  Durante a montagem devem ser utilizadas luvas de protecção, de modo a evitar ferimentos resultantes de entalamentos e de cortes.
-  Grandes diferenças entre as pressões das águas quente e fria devem ser compensadas.

### **3285XXX:**

-  Apenas as máquinas de lavar loiça ou as máquinas de lavar roupa que têm a posto o símbolo DVGW podem ser conectadas à válvula de ligação do aparelho, sem a utilização de um dispositivo de protecção complementar. Se a válvula de ligação do aparelho não for conectada a nenhum consumidor é necessário fechá-la.

## Avisos de montagem

- A misturadora deve ser instalada, purgada e testada de acordo com as normas em vigor!

## Dados Técnicos

Pressão de funcionamento:	max. 1 MPa
Pressão de func. recomendada:	0,1 - 0,5 MPa
Pressão testada:	1,6 MPa
(1 MPa = 10 bar = 147 PSI)	
Temperatura da água quente:	max. 80 °C
Temp. água quente recomendada:	65 °C

As misturadoras Hansgrohe podem ser utilizadas com esquentadores (de controlo térmico ou hidráulico) desde que a pressão de utilização seja, no mínimo, de 0,15 MPa.

## Descrição do símbolo



Não utilizar silicone que contenha ácido acético!



Misturadora monocomando equipada com limitador de temperatura (vide pág. 32.). Em combinação com caldeira ou esquentador instantâneo o limitador de água quente não se aplica.



Consultar a seguinte brochura sobre as recomendações de limpeza.



**Medidas** (ver página 33)



**Fluxograma**  
(ver página 33)



**Funcionamento** (ver página 35)



**Peças de substituição**  
(ver página 34)

XXX = Acabamentos  
000 = cromado  
800 = aço imaculado ótica



**Marca de controlo**  
(ver página 36)





## Wskazówki bezpieczeństwa

- ⚠ Aby uniknąć zranień, takich jak zgniecenia czy przecięcia, podczas montażu należy nosić rękawice.
- ⚠ Znaczne różnice ciśnień na doptywach ciepłej i zimnej wody muszą zostać wyrównane.

### 32855XXX:

- ⚠ Bez dodatkowego zabezpieczenia do zaworu przyłączeniowego urządzenia można podłączyć jedynie zmywarkę lub pralkę posiadającą znaczek DVGW. Gdy do zaworu przyłączeniowego urządzenia nie podłącza się żadnego odbiornika, należy go zaślepić.

## Wskazówki montażowe

- Armatura musi być zamontowana, przepłukana i wypróbowana według obowiązujących norm!

## Dane techniczne

Ciśnienie robocze:	maks. 1 MPa
Zalecane ciśnienie robocze:	0,1 – 0,5 MPa
Ciśnienie próbne:	1,6 MPa
(1 MPa = 10 bary = 147 PSI)	
Temperatura wody gorącej:	maks. 80 °C
Zalecana temperatura wody gorącej:	65 °C

Armatura Hansgrohe może być stosowana z przepływowymi podgrzewaczami wody sterowanymi hydraulicznie i termicznie w przypadku, gdy ciśnienie przepływu wynosi co najmniej 0,15 MPa.

## Opis symbolu



Nie stosować silikonów zawierających kwas octowy!



Mieszacz jednouchwytowy z ogranicznikiem temperatury wody, ustawianie, patrz str. 32. W połączeniu z przepływowym podgrzewaczem wody ogranicznik temperatury wody nie jest konieczny.



Zalecenie dotyczące pielęgnacji, patrz dołączona broszura.



**Wymiary** (patrz strona 33)



**Schemat przepływu**  
(patrz strona 33)



**Obsługa** (patrz strona 35)



**Części serwisowe**  
(patrz strona 34)

XXX = kody wykończenia powierzchni  
000 = chrom  
800 = stal szlachetna





**Znak jakości** (patrz strona 36)



## Montaż patrz strona 31



## **Bezpečnostní pokyny**

-  Pro zabránění řezným zraněním a pohmožděninám je nutné při montáži nosit rukavice.
-  Je nutné vyrovnat velké rozdíly tlaku mezi přípoji studené a teplé vody.

### **3285XXX:**

-  Na ventil pro připojení zařízení se smí bez přídavné pojistky připojit jen myčky nebo pračky se značkou DVGW. Pokud nebude k připojovacímu ventilu napojen žádný spotřebič, je nutné ho opatřit zásepkou.

## **Pokyny k montáži**

- Armatura se musí montovat, proplachovat a testovat podle platných norem!

## **Technické údaje**

Provozní tlak:	max. 1 MPa
Doporučený provozní tlak:	0,1 – 0,5 MPa
Zkušební tlak:	1,6 MPa
(1 MPa = 10 bar = 147 PSI)	
Teplota horké vody:	max. 80 °C
Doporučená teplota horké vody:	65 °C

Armatury Hansgrohe je možno používat v kombinaci s hydraulicky a tepelně řízenými průtokovými ohřivači v případě, že tlak činí minimálně 0,15 MPa.

## **Popis symbolů**



Nepoužívat silikon s obsahem kyseliny octové!



Páková baterie s omezením horké vody, seřízení viz. str. 32. Ve spojení s průtokovými ohřivači není uzávěr teplé vody nutný.



Doporučení k čištění viz příložená brožura.



**Rozměry** (viz strana 33)



**Diagram průtoku**  
(viz strana 33)



**Ovládání** (viz strana 35)



**Servisní díly** (viz strana 34)

XXX = kód povrchové úpravy  
000 = chrom  
800 = nerezová ocel



**Zkušební značka** (viz strana 36)





## **Bezpečnostné pokyny**

- ⚠ Pri montáži musíte nosiť rukavice, aby ste predišli pomliaždeninám a rezným poraneniam.
- ⚠ Veľké rozdiely v tlaku medzi prípojkami studenej a teplej vody musia byť vyrovnané.

### **32855XXX:**

- ⚠ K ventilu pripojenia zariadení je možné bez dodatočného zaistenia pripojiť len umýv ačku riadu alebo práčku so značkou DVGW. Ak nebude k pripojovaciemu ventilu pripojený žiaden spotrebič, musí byť tento opatrený záslepkou.

## **Pokyny pre montáž**

- Batéria sa musí montovať, preplachovať a testovať podľa platných noriem!

## **Technické údaje**

Prevádzkový tlak:	max. 1 MPa
Doporučený prevádzkový tlak:	0,1 – 0,5 MPa
Skúšobný tlak:	1,6 MPa
(1 MPa = 10 bar = 147 PSI)	
Teplota teplej vody:	max. 80 °C
Doporučená teplota teplej vody:	65 °C

Batérie Hansgrohe môžete používať v spojení s hydraulickými a tepelne ovládanými prietokovými ohrievačmi, ak je tlak minimálne 0,15 MPa.

## **Popis symbolov**



Nepoužívať silikón s obsahom kyseliny octovej!



Páková batéria s obmedzením teplej vody, nastavenie vid' str. 32. V spojení s prietokovými ohrievačmi nie je uzáver teplej vody nutný.



Odporúčanie o čistení nájdete v priloženej brožúre.



**Rozmery** (vid' strana 33)



**Diagram prietoku**  
(vid' strana 33)



**Obsluha** (vid' strana 35)



**Servisné diely** (vid' strana 34)

XXX = kód povrchovej úpravy  
000 = chróm  
800 = nerezova ocel



**Osvedčenie o skúške**  
(vid' strana 36)





## 安全技巧

- △ 装配时为避免挤压和切割受伤，必须戴上手套。
- △ 冷热水管间过大的压力差必须予以平衡。

32855XXX:

- △ 只有那些带有DVGW标记的洗衣机或洗碗机才可以不需附加其他安全设备而直接连接到本产品的外接设备供水阀上。用户不得连接本产品的外接设备供水阀，必须把它堵起来。

## 安装提示

- 必须按照现行的规定安装，冲洗和测试产品！

## 技术参数

工作压强:	最大 1 MPa
推荐工作压强:	0,1 0,5 MPa
测试压强:	1,6 MPa
(1 MPa = 10 bar = 147 PSI)	
热水温度:	最大 80° C
推荐热水温度:	65° C

如果水压达到0,15 MPa以上，汉斯格雅双手柄龙头可以和液压式或热控式连续流热水器一起使用。

## 符号说明



请勿使用含有乙酸的硅！



带有热水控制器的单手柄龙头的调节方法，参见第 32页。如果与连续流热水器一起使用，则不必作任何调节。



清洁建议参见附入的小册子。



大小 (参见第 33 页)



流量示意图  
(参见第 33 页)



操作 (参见第 35 页)



备用零件 (参见第 34 页)

XXX = 颜色代码  
000 = 镀铬  
800 = 不锈钢表面



检验标记 (参见第 36 页)



安装 参见第 31 页



## Указания по технике безопасности

- ⚠ Во время монтажа следует надеть перчатки во избежание прищемления и порезов.
- ⚠ донного клапа. Перед установкой смесителя необходимо регулировочными кранами выровнять давление холодной и горячей воды при помощи вентилей регулирующих подачу воды в квартиру.

### 3285XXX:

- ⚠ Без дополнительного предохранителя к вентилю для подключения приборов разрешается подключать только посудомоечные или стиральные машины со знаком DVGW. Если к вентилю для подключения приборов не подключено ни одного приемника, то его необходимо закрыть.

## Указания по монтажу

- Смеситель должен быть смонтирован по действующим нормам и в соответствии с настоящей инструкцией, проверен на герметичность и безупречность работы

## Технические данные

Рабочее давление: не более 1 МПа  
 Рекомендуемое рабочее давление: 0,1 – 0,5 МПа  
 Давления: 1,6 МПа  
 (1 МПа = 10 bar = 147 PSI)  
 Температура горячей воды: не более 80 °С  
 Рекомендуемая темп. гор. воды: 65 °С

Арматуры Hansgrohe могут использоваться в комбинации с проточными нагревателями с гидравлическим и термическим управлением, если давление истечения составляет не менее 0,15 МПа.

## Описание символов



Не применяйте силикон, содержащий искусственную кислоту.



Однорычажный смеситель имеет ограничитель расхода горячей воды (см. Стр. 32: юстировка).



Рекомендации по очистке см. в прилагаемой брошюре.



**Размеры** (см. стр. 33)



**Схема потока**  
(см. стр. 33)



**Эксплуатация** (см. стр. 35)



**Комплект** (см. стр. 34)

XXX = Код цвета поверхности  
 000 = хром  
 800 = сталь





**Знак технического контроля**  
(см. стр. 36)





## Biztonsági utasítások

-  A szerelésnél a zúzódások és vágási sérülések elkerülése érdekében kesztyűt kell viselni.
-  A hidegvíz- és a melegvíz-csatlakozások közötti nagy nyomáskülönbséget kikell egyenlíteni!

### 32855XXX:

-  Csak a DVGW-jelzéssel ellátott mosogató- vagy mosógépeket szabad kiegészítő biztosítás nélkül a készülék csatlakozószelepéhez csatlakoztatni. Amennyiben nem csatlakoztatnak felhasznált a készülék csatlakozószelepéhez, akkor ezt be kell dugaszolni.

## Szerelési utasítások

- A csaptelepet az érvényben lévő előírásoknak megfelelően kell felszerelni, átöblíteni és ellenőrizni!

## Műszaki adatok

Üzemi nyomás:	max. 1 MPa
Ajánlott üzemi nyomás:	0,1 – 0,5 MPa
Nyomáspróba:	1,6 MPa
(1 MPa = 10 bar = 147 PSI)	
Forróvíz hőmérséklet:	max. 80 °C
Forróvíz javasolt hőmérséklete:	65 °C

A Hansgrohe csaptelepek hidraulikus és termikus vezérlésű átfolyós melegítővel kapcsolatban is használhatóak, ha az átfolyó nyomás legalább 0,15 MPa.

## Szimbólumok leírása



Ne használjon ecetsavtartalmú szilikon!



Az egykaros, melegvíz-korlátozóval ellátott keverő csaptelep beállítását lásd a 32. oldalon. Az átfolyó rendszerű vízmelegítőknél nem szükséges a melegvíz-korlátozó.



Az ajánlott tisztításhoz lásd a mellékelt brosúrát.



**Méretet** (lásd a 33. oldalon)



**Átfolyási diagramm** (lásd a 33. oldalon)



**Használat** (lásd a 35. oldalon)



**Tartozékok** (lásd a 34. oldalon)

XXX = Színkódok  
000 = króm  
800 = acéloptika





**Vizsgajel** (lásd a 36. oldalon)



**Szerelés lásd a 31. oldalon**



## Turvallisuusohjeet

-  Asennuksessa on käytettävä käsineitä puristumien ja viiltojen aiheuttamien tapaturmien estämiseksi.
-  Suuret paine-erot kylmä- ja kuumavesiliitäntöjen välillä on tasattava.

### **3285XXX:**

-  Vain sellaiset astian- tai pyykinpesukoneet, joissa on DVGW-merkintä, saa kytkeä ilman lisävarmistusta laiteliittimeen. Jos liitäntäventtiiliin ei liitetä konetta, se on tukittava.

## Asennusohjeet

- Kaluste on asennettava, huuhdeltava ja tarkastettava voimassa olevien määräysten mukaisesti!

## Tekniset tiedot

Käyttöpaine:	maks. 1 MPa
Suosittelut käyttöpaine:	0,1 – 0,5 MPa
Koestuspaine:	1,6 MPa
(1 MPa = 10 bar = 147 PSI)	
Kuuman veden lämpötila:	maks. 80 °C
Kuuman veden suosituslämpötila:	65 °C

Hansgrohe kalusteita voi käyttää hydraulisesti tai termisesti ohjattujen läpivirtauskuumentimien yhteydessä, jos virtauspaine on vähintään 0,15 MPa.

## Merkin kuvaus



Älä käytä etikkahappopitoista silikonial!



Yksivipuinen sekoittaja lämpimän veden rajoituksella, katso säätö sivulta 32. Lämpimän veden rajoitusta ei tarvita läpivirtauskuumentimen yhteydessä.



Katso puhdistussuositus mukana olevasta esitteestä.



**Mitat** (katso sivu 33)



**Virtausdiagrammi**  
(katso sivu 33)



**Käyttö** (katso sivu 35)



**Varaosat** (katso sivu 34)

XXX = Värikoodi  
000 = kromi  
800 = inox-optinen





**Koestusmerkki** (katso sivu 36)







## Säkerhetsanvisningar

-  Handskar ska bäras under monteringsarbetet så att man kan undvika kläm- och skärskadorgen werden.
-  Stora tryckskillnader mellan anslutningarna för varmt och kallt vatten måste utjämnas.

### 3285XXX:

-  Endast disk- och tvättmaskiner som är försedda med DVGW-märkning får anslutas till kopplingsventilen utan extra uppsäkring. Om ingen förbrukare ansluts till kopplingsventilen måste denna sättas igen.

## Monteringsanvisningar

- Blandaren måste installeras, genomspolas och testas enligt gällande föreskrifter.

## Tekniska data

Driftstryck:	max. 1 MPa
Rek. driftstryck:	0,1 – 0,5 MPa
Tryck vid provtryckning: (1 MPa = 10 bar = 147 PSI)	1,6 MPa
Varmvattentemperatur:	max. 80 °C
Rek. varmvattentemp.:	65 °C

Hansgrohe blandare kan användas tillsammans med hydrauliskt och termiskt styrda varmvattenberedare när flödestrycket uppgår till minst 0,15 MPa.

## Simbolio aprašymas



Använd inte silikon som innehåller ättiksyra!



Enhandsblandare med varmvattenreglering, justering se sidan 32. Vid användning tillsammans med varmvattenberedare behövs ingen varmvattenreglering.



Se den medföljande broschyren för rengöringsrekommendation



**Måtten** (se sidan 33)



**Pralaidumo diagrama**  
(se sidan 33)



**Hantering** (se sidan 35)



**Reservdelar** (se sidan 34)

XXX = Färgkodning  
000 = krom  
800 = rostfri-optik





**Testsigill** (se sidan 36)





## Saugumo technikos nurodymai

-  Apsaugai nuo užspaudimo ir įsijovimo montavimo metu mūvėkite pirštines.
-  Turi būti išlyginti šalto ir karšto slėgio nelygumai.

### **32855XXX:**

-  Be papildomos apsaugos prie įrenginio jungiamojo vožtuvo junkite tik skalbimo arba indų plovimo mašinas, turinčias DVGW ženklą. Jeigu prie įrenginio prijungimo vožtuvo neprijungtas joks prietaisas, jis turi būti sandariai uždarytas.

## Montavimo instrukcija

- Maišytuvą privalo būti montuojamas, išleidžiamas ir patikrinamas pagal galiojančias normas!

## Techniniai duomenys

Darbinis slėgis: ne daugiau kaip 1 MPa  
 Rekomenduojamas slėgis: 0,1 – 0,5 MPa  
 Bandomasis slėgis: 1,6 MPa  
 (1 MPa = 10 barų = 147 PSI)  
 Karšto vandens temperatūra: ne daugiau kaip 80 °C  
 Rekomenduojama karšto vandens temperatūra: 65 °C

„Hansgrohe“ maišytuvai gali būti naudojami su hidrauliškai ir termiškai reguliuojamais momentiniais šildikliais, kai vandens slėgis mažesnis kaip 0,15 MPa.

## Simbolio aprašymas



Nenaudokite silikono, kurio sudėtyje yra acto rūgšties!



Vienos rankenėlės maišytuvą turi karšto vandens ribotuvą (nustatymą žr. psl. 32). Naudojant momentinį šildiklį karšto vandens ribotuvą nebūtina.



Valymo rekomendacijas žr. pridedamoje brošiūroje.



**Išmatavimai** (žr. psl. 33)



**Pralaidumo diagrama**  
(žr. psl. 33)



**Eksplotacija** (žr. psl. 35)



**Atsarginės dalys** (žr. psl. 34)

XXX = Spalva  
 000 = chrom  
 800 = plienas





**Bandyimo pažyma** (žr. psl. 36)





## Sigurnosne upute

-  Prilikom montaže se radi sprječavanja prignječenja i posjekotina moraju nositi rukavice.
-  Velika razlika u pritisku između vruće i hladne vode mora biti izbalansirana.

### 32855XXX:

-  Samo perilice za suđe ili rublje sa oznakom DVGW smijete koristiti bez dodatnog osiguranja priključnog ventila! Ako se na priključni ventil uređaja ne priključuje niti jedan potrošač, isti se mora začepiti.

## Upute za montažu

- Cijevi moraju biti postavljene, isprane i testirane prema važećim normama!

## Tehnički podatci

Najveći dopušteni tlak:	tlak 1 MPa
Preporučeni tlak:	0,1 – 0,5 MPa
Probni tlak:	1,6 MPa
(1 MPa = 10 bar = 147 PSI)	
Temperatura vruće vode:	tlak 80 °C
Preporučena temperatura vruće vode:	65 °C

Hansgrohe armature mogu se koristiti u kombinaciji sa hidraulički i termički kontroliranim protočnim bojlerima ukoliko tlak iznosi najmanje 0,15 MPa

## Opis simbola



Nemojte koristiti silikon koji sadrži octenu kiselinu!



Da bi podesili limiter vruće vode na jednoručnim slavinama molimo Vas da pogledate stranicu 32. Podešavanje nije potrebno ako koristite protočni bojler.



Upute za čišćenje nalaze se u priloženoj brošuri.



**Mjere** (pogledaj stranicu 33)



**Dijagram protoka** (pogledaj stranicu 33)



**Upotreba** (pogledaj stranicu 35)



**Rezervni dijelovi** (pogledaj stranicu 34)

XXX = Boje  
000 = krom  
800 = plemeniti čelik



**Oznaka testiranja** (pogledaj stranicu 36)





## ! Güvenlik uyarıları

- ⚠ Montaj esnasında ezilme ve kesilme gibi yaralanmaları önlemek için eldiven kullanılmalıdır.
- ⚠ Sıcak ve soğuk su bağlantıları arasında büyük basınç farklılıkları varsa, bu basınç farklılıklarının dengelenmesi gerekir.

### 3285XXX:

- ⚠ Sadece DVGW işaretine sahip bulaşık ya da çamaşır makineleri ek emniyet olmadan cihaz bağlantı valfine bağlanmalıdır. Cihaz bağlantı valfine bir tüketici bağlanmayacaksa, bunun tapa ile kapatılması gerekir.

## Montaj açıklamaları

- Batarya geçerli normlara göre monte edilmeli, yıkanmalı ve kontrol edilmelidir!

## Teknik bilgiler

İşletme basıncı:	azami 1 MPa
Tavsiye edilen işletme basıncı:	0,1 – 0,5 MPa
Kontrol basıncı:	1,6 MPa
(1 MPa = 10 bar = 147 PSI)	
Sıcak su sıcaklığı:	azami 80 °C
Tavsiye edilen su ısı:	65 °C

Hansgrohe bataryaları, akış basıncı en az 0,15 MPa olursa hidrolik ve termik kumandalı şofbenlerle bağlantılı olarak kullanılabilir.

## Simge açıklaması



Asetik asit içeren silikon kullanmayın!



Sıcak su sınırlayıcı özelliğine sahip tek kollu bataryanın ayarlanması için 32. sayfaya bakınız. Bir sürekli akışlı su ısıtıcısı ile birlikte kullanılırsa sıcak su sınırlayıcısına gerek kalmaz.



Temizlik önerisi için birlikte verilen broşüre bakınız.



**Ölçüleri** (Bakınız sayfa 33)



**Akış diyagramı**  
(Bakınız sayfa 33)



**Kullanımı** (Bakınız sayfa 35)



**Yedek Parçalar**  
(Bakınız sayfa 34)

XXX = Renkler

000 = krom

800 = paslanmaz çelik - optik





**Kontrol işareti** (Bakınız sayfa 36)





## Instrucțiuni de siguranță

-  La montare utilizați mănuși pentru evitarea contuziunilor și tăierii mâinilor.
-  Diferențele de presiune mari între alimentarea cu apă rece și apă caldă trebuie echilibrate.

### **32855XXX:**

-  Conectați numai mașinile de spălat sau mașinile de spălat vase fără siguranță adițională la ventilul de conectare a aparatului, care sunt marcate cu simbolul DVGW. Dacă la ventilul de conectare a aparatului nu conectați nici un consumator, acesta trebuie închis.

## Instrucțiuni de montare

- Bateria trebuie montată, clătită și verificată conform normelor în vigoare.

## Date tehnice

Presiune de funcționare:	max. 1 MPa
Presiune de funcționare recomandată:	0,1 – 0,5 MPa
Presiune de verificare:	1,6 MPa
(1 MPa = 10 bar = 147 PSI)	
Temperatura apei calde:	max. 80 °C
Temperatura recomandată a apei calde:	65 °C

Bateriile Hansgrohe pot fi utilizate cu boiler instant cu comandă termică sau hidraulică dacă presiunea apei de alimentare este de min. 0,15 MPa.

## Descrierea simbolurilor



Nu utilizați silicon cu conținut de acid acetic!



Bateria monocomadă cu limitarea apei calde, pentru reglare vezi pag. 32. Dacă conectați bateria la un boiler instant nu este necesară instalarea unui opritor de apă caldă.



Pentru recomandările referitoare la curățare vezi broșura alăturată.



**Dimensiuni** (vezi pag. 33)



**Diagrama de debit**  
(vezi pag. 33)



**Utilizare** (vezi pag. 35)



**Piese de schimb** (vezi pag. 34)

XXX = cod de culori  
000 = crom  
800 = oțel inox



**Certificat de testare**  
(vezi pag. 36)



**Montare vezi pag. 31**



## ⚠ Υποδειξεις ασφαλείας

- ⚠ Για να αποφύγετε τραυματισμούς κατά τη συναρμολόγηση πρέπει να φοράτε γάντια.
- ⚠ Οι διαφορές της πίεσης μεταξύ της σύνδεσης κρύου και ζεστού νερού θα πρέπει να αντισταθμίζονται.

### 32855XXX:

- ⚠ Μόνο πλυντήρια πιάτων ή πλυντήρια ρούχων που φέρουν το σήμα DVGW επιτρέπεται να συνδεθούν στη βαλβίδα σύνδεσης της συσκευής χωρίς πρόσθετη ασφάλεια. Αν δεν συνδεθεί κάποιος καταναλωτής στη βαλβίδα σύνδεσης της συσκευής, ταπώστε τη βαλβίδα.

## Οδηγίες συναρμολόγησης

- Η κεντρική βάνα πρέπει να τοποθετηθεί, να πλυθεί και να ελεγχθεί με βάση τους ισχύοντες κανόνες υδραυλικής τέχνης!

## Τεχνικά Χαρακτηριστικά

Λειτουργία πίεσης:	έως 1 MPa
Συνιστώμενη λειτουργία πίεσης:	0,1 – 0,5 MPa
Πίεση ελέγχου:	1,6 MPa (1 MPa = 10 bar = 147 PSI)
Θερμοκρασία ζεστού νερού:	έως 80 °C
Συνιστώμενη θερμοκρασία ζεστού νερού:	65 °C

Οι βάνες Hansgrohe μπορούν να συνδυαστούν με ταχυθερμοσίφωνες υδραυλικού και θερμικού ελέγχου, όταν η πίεση ροής αριθμεί τουλάχιστον 0,15 MPa.

## Περιγραφή συμβόλων



Μην χρησιμοποιείτε σιλικόνη που περιέχει οξικό οξύ!



Για να προσαρμόσετε το δοσομετρική ζεστού νερού σε αναμεικτικές μπαταρίες, παρακαλούμε δείτε τη ρύθμιση στη σελ. 32. Δεν είναι απαραίτητη η διάταξη φραγής ζεστού νερού σε συνδυασμό με ταχυθερμοσίφωνα.



Για οδηγίες καθαρισμού βλ.επε συνημμένο ενημερωτικό φυλλάδιο.



**Διαστάσεις** (βλ. σελίδα 33)



**Διάγραμμα ροής**  
(βλ. σελίδα 33)



**Χειρισμός** (βλ. σελίδα 35)



**Ανταλλακτικά** ( βλ. σελίδα 34 )

XXX = Χρώματα  
000 = Επιχρωματωμένο  
800 = οπτική ανοξείδωτου χάλυβα





**Σήμα ελέγχου** (βλ. σελίδα 36)





## Varnostna opozorila

-  Pri montaži je treba nositi rokavice, da se preprečijo poškodbe zaradi zmečkanja ali urezov.
-  Velike razlike v tlaku med priključkom za mrzlo in priključkom za toplo vodo je potrebno izravnati.

### **3285XXX:**

-  Na priključni ventil priprave se smejo brez dodatne zaščite priklopiti le pomivalni ali pralni stroji z znakom kakovosti DVGW. Če se na priključni ventil priprave ne priklopi nobenega porabnika, je treba ventil zamašiti.

## Navodila za montažo

- La robinetterie doit être installée, rincée et contrôlée conformément aux normes valables!

## Tehnični podatki

Delovni tlak:	maks. 1 MPa
Priporočeni delovni tlak:	0,1 – 0,5 MPa
Preskusni tlak:	1,6 MPa
(1 MPa = 10 bar = 147 PSI)	
Temperatura tople vode:	maks. 80 °C
Priporočena temperatura tople vode:	65 °C

Armature Hansgrohe lahko uporabljate v povezavi s hidravlično in termično uravnavanimi pretočnimi grelniki, če je pretočni tlak najmanj 0,15 MPa.

## Opis simbola



Ne smete uporabiti silikona, ki vsebuje ocetno kislino!



Enoročne mešalne baterije z omejevalnikom tople vode, za justiranje glejte stran 32. V povezavi s pretočnimi grelniki zapora tople vode ni potrebna.



Priporočilo za čiščenje glejte v priloženi brošuri.



**Mere** (glejte stran 33)



**Diagram pretoka** (glejte stran 33)



**Upravljanje** (glejte stran 35)



**Rezervni deli** (glejte stran 34)

XXX = Barve  
000 = krom  
800 = videz legiranega jekla





**Preskusni znak** (glejte stran 36)





## Ohutusjuhised

-  Kandke paigaldamisel muljumis- ja löikevigastuste vältimiseks kindaid.
-  Kui külma ja kuuma vee ühenduste surve on väga erinev, tuleb need tasakaalustada.

### 3285XXX:

-  Seadme ühendusklapiga võib ühendada ainult DVGW-tähisega nõudepesu- või pesumasina. Kui seadme ühendusklapiga ei ühendata ühtki tarbijat, tuleb see sulgeda.

## Paigaldamisjuhised

- Segisti paigaldamine, loputamine ja kontroll peab toimuma vastavalt kehtivatele normidele!

## Tehnilised andmed

Töörõhk	maks. 1 MPa
Soovitatav töörõhk:	0,1 – 0,5 MPa
Kontrollsurve:	1,6 MPa
(1 MPa = 10 baari = 147 PSI)	
Kuuma vee temperatuur:	maks. 80 °C
Soovitatav kuuma vee temperatuur:	65 °C

Hansgrohe segisteid võib kasutada koos hüdrauliliselt ja termiliselt juhitavate boileritega, kui vee surve on vähemalt 0,15 MPa.

## Sümbolite kirjeldus



Ärge kasutage äädikhapet sisaldavat silikooni!



Ühe juhtkangiga segisti kuuma vee piiraja reguleerimise kohta vt lk 32. Läbivoolu boilerite puhul pole reguleerimine vajalik.



Puhastussoovitusi vt kaasasolevast brošüürist.



**Mõõtude** (vt lk 33)



**Läbivooludiagramm**  
(vt lk 33)



**Kasutamine** (vt lk 35)



**Varuosad** (vt lk 34)

XXX = Värvikood  
000 = kroom  
800 = roostevaba optik



**Kontrollsertifikaat** (vt lk 36)







## Drošības norādes

- ⚠ Montāžas laikā, lai izvairītos no saspiedumiem un iegriezumiem, nepieciešams nēsāt cimdus.
- ⚠ Jāizlīdzina spiediena atšķirības starp aukstā un karstā ūdens pievadiem.

### 3285XXX:

- ⚠ Ierīču pieslēgšanas vārstam drīkst pieslēgt bez papildus nodrošinājuma tikai tās trauku mazgājamās mašīnas un veļas mašīnas, kurām ir DVGW-zīme. Ja ierīču pieslēgšanas vārstam nav pieslēgta neviena ierīce, tas jāaizblīvē.

## Norādījumi montāžai

- Armatūra jāuzstāda, jāizskalo un jāpārbauda atbilstoši spēkā esošajām normām!

## Tehniskie dati

Darba spiediens:	maks. 1 MPa
Ieteicamais darba spiediens:	0,1 – 0,5 MPa
Pārbaudes spiediens:	1,6 MPa
(1 MPa = 10 bar = 147 PSI)	
Karstā ūdens temperatūra:	maks. 80 °C
Ieteicamā karstā ūdens temperatūra:	65 °C

Hansgrohe jaucējkrānus var izmantot kombinācijā ar hidrauliski un termiski vadāmiem caurteces sildītājiem, ja plūsmas spiediens ir vismaz 0,15 MPa.

## Simbolu nozīme



Neizmantojiet silikonu, kas satur etiķskābi!



Viensviras jaucējkrāns ar siltā ūdens ierobežošanu, ieregulēšanu skat. 32. lpp. Kombinācijā ar caurteces sildītāju karstā ūdens ierobežošana nav nepieciešama.



Ieteikumus tīrīšanai skatiet pievienotajā brošūrā.



Izmērus (skat. 33. lpp.)



Caurplūdes diagramma (skat. 33. lpp.)



Lietošana (skat. 35. lpp.)



Rezerves daļas (skat. 34. lpp.)

XXX = Krāsas  
000 = hroma  
800 = tērauda



Pārbaudes zīme (skat. 36. lpp.)





## Sigurnosne napomene

- ⚠ Prilikom montaže se radi sprečavanja prignječenja i posekotina moraju nositi rukavice.
- ⚠ Velika razlika u pritisku između vruće i hladne vode mora biti izbalansirana.

### 3285XXX:

- ⚠ Samo mašine za veš ili suđe s oznakom DVGW se smeju priključivati bez dodatnog osiguranja priključnog ventila. Ako se na priključni ventil uređaja ne priključuje nijedan potrošač, isti se mora začepiti.

## Instrukcije za montažu

- Armatura mora biti postavljena, isprana i testirana prema važećim normama!

## Tehnički podaci

Radni pritisak:	maks. 1 MPa
Preporučeni radni pritisak:	0,1 – 0,5 MPa
Probni pritisak:	1,6 MPa
(1 MPa = 10 bar = 147 PSI)	
Temperatura vruće vode:	maks. 80 °C
Preporučena temperatura vruće vode:	65 °C

Hansgrohe armature se mogu koristiti u kombinaciji s hidraulički i termički kontrolisanim protočnim bojlerima ukoliko pritisak iznosi najmanje 0,15 MPa.

## Opis simbola



Nemojte koristiti silikon koji sadrži sirćetnu kiselinu!



Da bi ste podesili ograničavač vruće vode na jednoručnim mešačima, molimo Vas da pogledate stranicu 32. Podešavanje nije potrebno ako koristite protočni bojler.



Preporuke za čišćenje možete naći u priloženoj brošuri.



**Mere** (vidi stranu 33)



**Dijagram protoka**  
(vidi stranu 33)



**Rukovanje** (vidi stranu 35)



**Rezervni delovi** (vidi stranu 34)

XXX = Oznake boja  
000 = hrom  
800 = dezen plemeniti čelik





**Nepovratni ventil** (vidi stranu 36)





## Sikkerhetshenvisninger

-  Bruk hansker under montasjen for å unngå klem- og kuttskader.
-  Store trykkdifferanser mellom kaldt- og varmtvannstilkoblinger skal utlignes.

### 32855XXX:

-  Kun oppvask- eller vaskemaskiner med DVGW merke kan kobles uten tilleggssikring til ventilen for apparatetilkoblingen. Hvis ingen forbruker kobles til ventilen for apparatetilkoblingen, så skal ventilen tilstoppes.

## Montagehenvisninger

- Armaturen skal monteres iht. gyldige standarder. De skal spyles og sjekkes!

## Tekniske data

Driftstrykk	maks. 1 MPa
Anbefalt driftstrykk:	0,1 – 0,5 MPa
Prøvetrykk	1,6 MPa
(1 MPa = 10 bar = 147 PSI)	
Varmtvannstemperatur	maks. 80 °C
Anbefalt temperatur for varmt vann	65 °C

Armaturer fra Hansgrohe kan brukes sammen med hydraulisk og termisk strypte gjennomstrømningsovner når gjennomstrømningstrykket er på minst 0,15 MPa.

## Symbolbeskrivelse



Ikke bruk silikon som inneholder eddiksyre!



Enhåndblande batteri med varmtvannsbegrensning. For justering se side 32. I forbindelse med en gjennomstrømningsovner er det ikke nødvendig med varmtvannsbegrensning.



Se vedlagt brosjyre for rengjøringsanbefalinger.



**Mål** (se side 33)



**Gjennomstrømningsdiagram**  
(se side 33)



**Betjening** (se side 35)



**Service deler** (se side 34)

XXX = Označe boja  
000 = hrom  
800 = dezen plemeniti čelik



**Prøve merke** **Prøve merke**



**Montasje se side 31**



## **Указания за безопасност**

- ⚠ При монтажа трябва да се носят ръкавици, за да се избегнат наранявания поради притискане или порязване.
- ⚠ Големите разлики в налягането между изводите за студената и топлата вода трябва да се изравняват.

### **32855XXX:**

- ⚠ (вижте стр. 36) Ако към свързващия клапан на уреда не бъде свързан консуматор, той трябва да бъде запушен.

## **Указания за монтаж**

- Арматурата трябва да се монтира, промие и провери в съответствие с валидните норми!

## **Технически данни**

Работно налягане: макс. 1 МПа  
 Препоръчително работно налягане: 0,1 – 0,5 МПа  
 Контролно налягане: 1,6 МПа  
 (1 МПа = 10 bar = 147 PSI)  
 Температура на горещата вода: макс. 80 °C  
 Препоръчителна температура на горещата вода: 65 °C

Арматурите на Hansgrohe могат да се използват във връзка с хидравлично и термично управляеми проточни нагреватели, ако хидравличното налягане е минимум 0,15 МПа.

## **Описание на символите**



Не използвайте силикон, съдържащ оцетна киселина!



Смесител с една ръкохватка с ограничител за топлата вода, юстирането вижте на стр. 32. Във връзка с проточни нагреватели не е необходима блокировка за топлата вода.



Вижте препоръките при почистване от приложената брошура.



**Размери** (вижте стр. 33)



**Диаграма на потока**  
(вижте стр. 33)



**Обслужване** (вижте стр. 35)



**Сервизни части** (вижте стр. 34)

XXX = Oznake boja  
 000 = hrom  
 800 = dezen plemeniti čelik





**Контролен знак** (вижте стр. 36)





## Udhëzime sigurie

-  Për të evituar lëndimet e pickimeve ose të prerjeve gjatë procesit të montimit duhet që të vishni doreza.
-  Ndryshimet e mëdha të presionit mes lidhjeve të ujit të ftohtë dhe atij të ngrohtë duhen ekuilibruar.

### 3285XXX:

-  Vetëm makinat larëse të enëve ose rrobave që përmbajnë shenjën e DVGW mund të lidhen me ventilin e lidhjes së pajisjes pa sigurim të posaçëm. Vetëm makinat larëse të enëve ose rrobave që përmbajnë shenjën e DVGW mund të lidhen me ventilin e lidhjes së pajisjes pa sigurim të posaçëm.

## Udhëzime për montimin

- Armatura duhet montuar, shpërlarë dhe kontrolluar në bazë të normave të vlefshme!

## Të dhëna teknike

Presioni gjatë punës	maks. 1 MPa
Presioni i rekomanduar:	0,1 – 0,5 MPa
Presioni për provë:	1,6 MPa
(1 MPa = 10 bar = 147 PSI)	
Temperatura e ujit të ngrohtë	maks. 80 °C
Temperatura e rekomanduar e ujit të ngrohtë:	65 °C

Armaturat e Hansgrohe mund të përdoren në kombinim me ngrohës elektrikë të ujit të drejtuar në mënyrë hidraulike ose termike nëse presioni i rrjedhjes është minimumi 0,15 MPa.

## Përshkrimi i simbolit



Mos përdorni silikon që në përbërje ka acid acetik.



Rubinet me ujë të përzier me kufizim të ujit të ngrohtë, justimi shih faqen 32. Në kombinim me ngrohësit elektrikë të ujit nuk ka nevojë për bllokadë të ujit të ngrohtë.



Për rekomandime mbi pastrimin shikoni broshurën bashkëngjitur.



**Përmasat** (shih faqen 33)



**Diagrami i qarkullimit** (shih faqen 33)



**Përdorimi** (shih faqen 35)



**Pjesë ndërrimi** (shih faqen 34)

XXX = Oznake bojë  
000 = hrom  
800 = dezen plemeniti çelik



**Shenja e kontrollit** (shih faqen 36)





## وصف الرمز

هام! لا تستخدم السليكون الذي يحتوي على أحماض!



لضبط محدد الماء الساخن في الخلاطات ذات المقبض الواحد، يرجى الرجوع إلى صفحة 32. ولا يلزم إجراء أي ضبط عند استخدام سخان مياه ذي تدفق مستمر.



للاطلاع على النصائح الخاصة بالتنظيف انظر الكتيب المرفق.



أبعاد (راجع صفحة 33)



رسم للصراف (راجع صفحة 33)



التشغيل (راجع صفحة 35)



قطع الغيار (راجع صفحة 34)



XXX = الألوان  
000 = كروم  
800 = مظهر الإستنليس ستيل

شهادة اختبار (راجع صفحة 36)



## تنبيهات الأمان



يجب إرتداء قفازات لليد أثناء التركيب لتجنب حدوث أخطار الإنحشار أو الجروح.



يجب أن يكون تيار الماء الساخن والماء البارد متعادلين في الضغط.



## 32855XXX:

يمكن فقط توصيل غسالات الأطباق وغسالات الملابس التي تحمل علامة DVGW بصمام التوصيل بالأجهزة وبدون تأمين إضافي. يجب سد صمام التوصيل بالأجهزة في حالة عدم توصي أية أجهزة.



## تعليمات التركيب

- يجب تركيب الوصلة، وغمرها بالماء واختبارها وفقاً للمعايير السارية!

## المواصفات الفنية

ضغط التشغيل:  
ضغط التشغيل الموصى به:  
ضغط الاختبار:  
(1 ميجاباسكال = 10 بار = 147 PSI)  
درجة حرارة الماء الساخن:  
درجة الحرارة الموصى بها للماء الساخن:

الحد الأقصى 1 ميجاباسكال  
0,1 – 0,5 ميجاباسكال  
1,6 ميجاباسكال

الحد الأقصى 80°C  
65°C

يمكن استخدام خلاطات هانزجر وهي مع سخانات تدفق الماء ذات التحكم الهيدروليكي والحراري، مع ضغط تدفق لا يقل عن 0,15 ميجاباسكال.



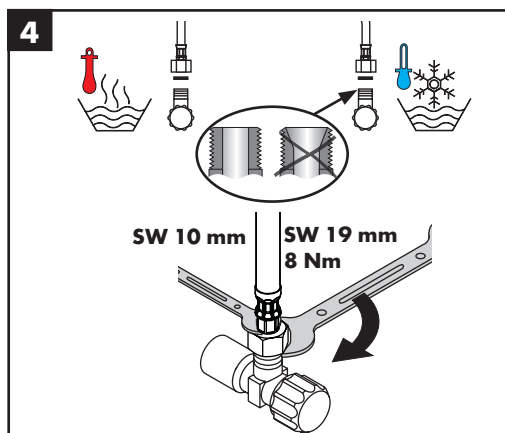
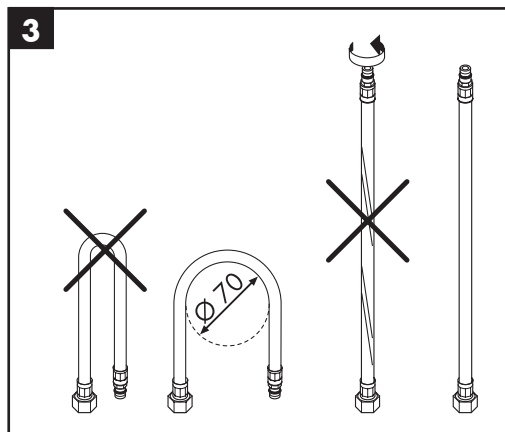
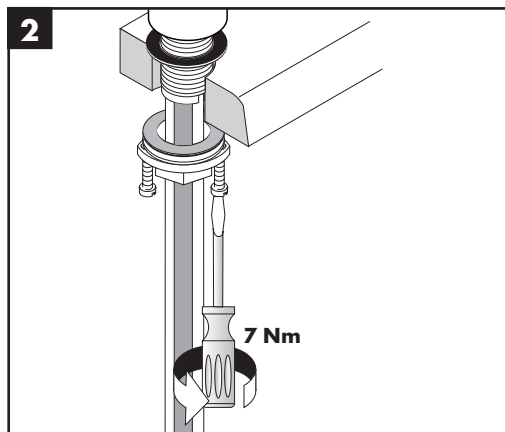
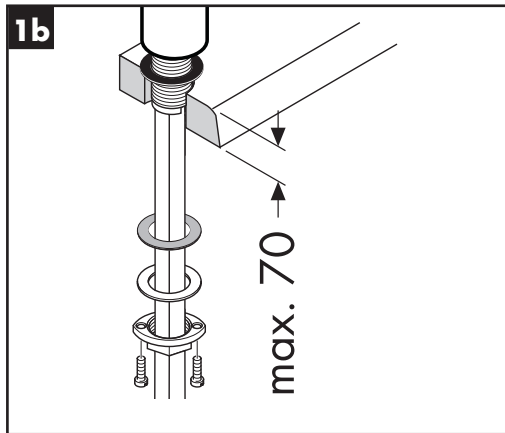
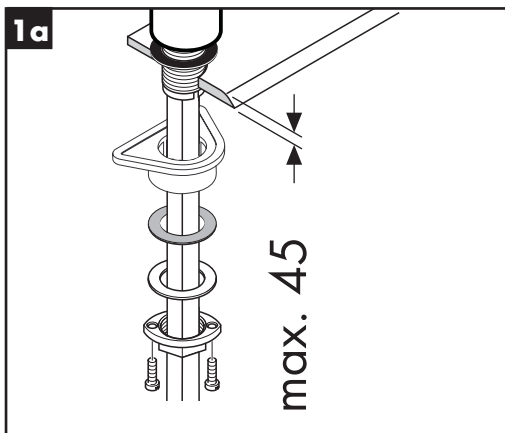

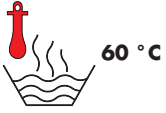

60 °C



10 °C



0,3 MPa  
0,3 МПа  
0,3 میجابسکال

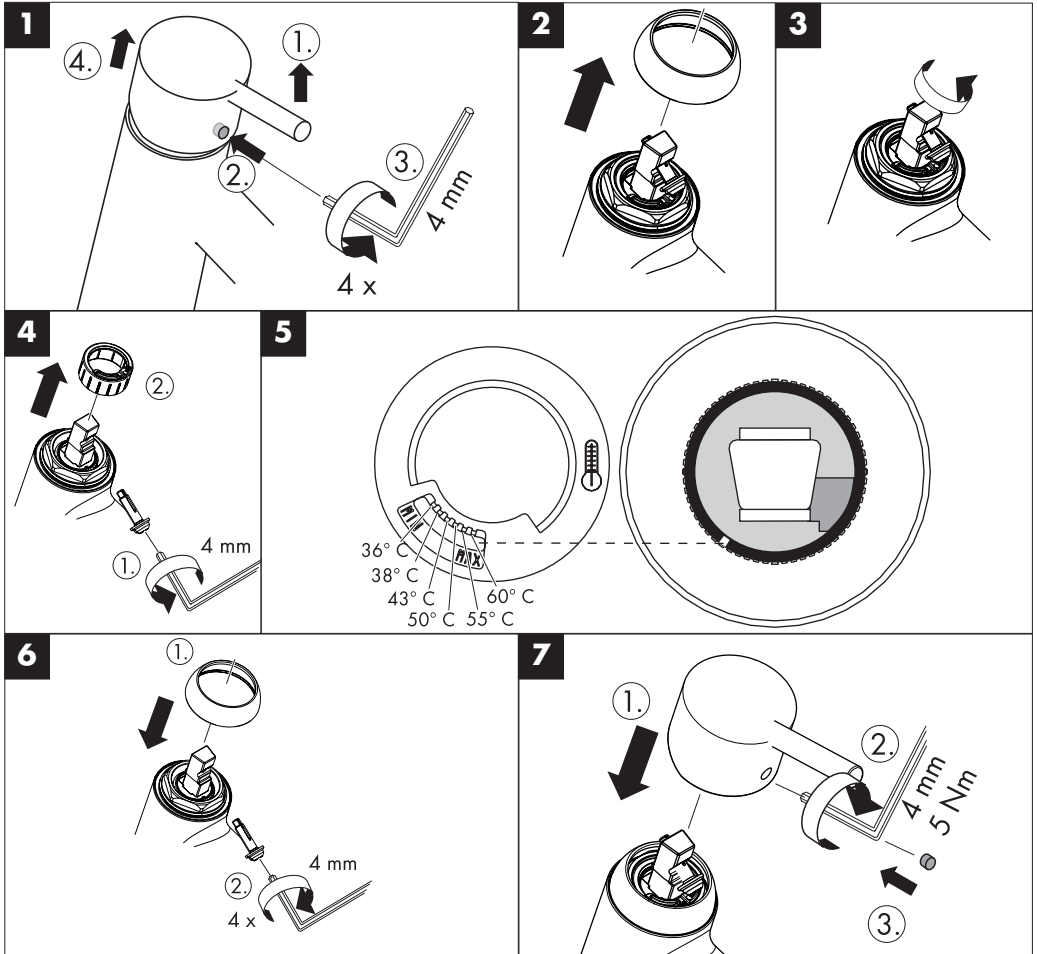



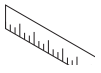

**Talis S**  
32851XXX

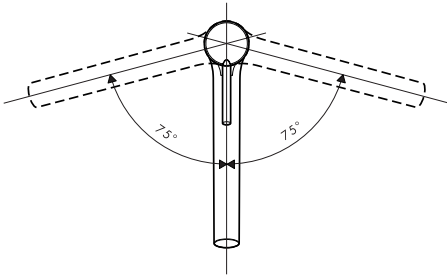
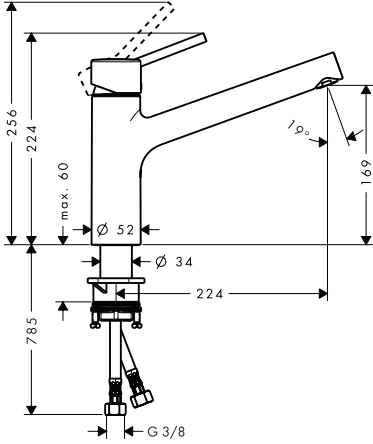

**Talis S**  
32855XXX

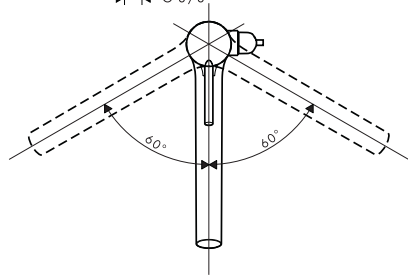
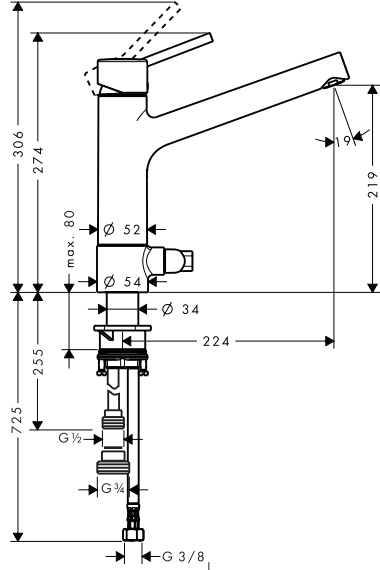

**Talis S**  
32851XXX

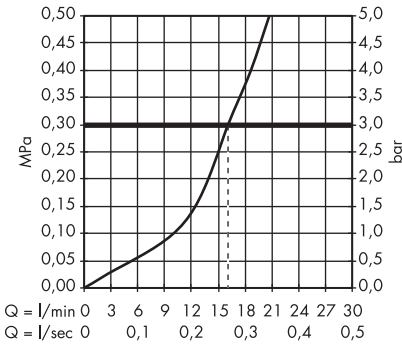

**Talis S**  
32855XXX

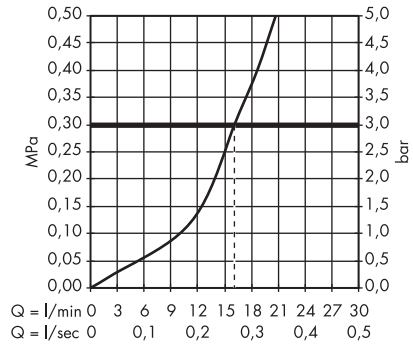

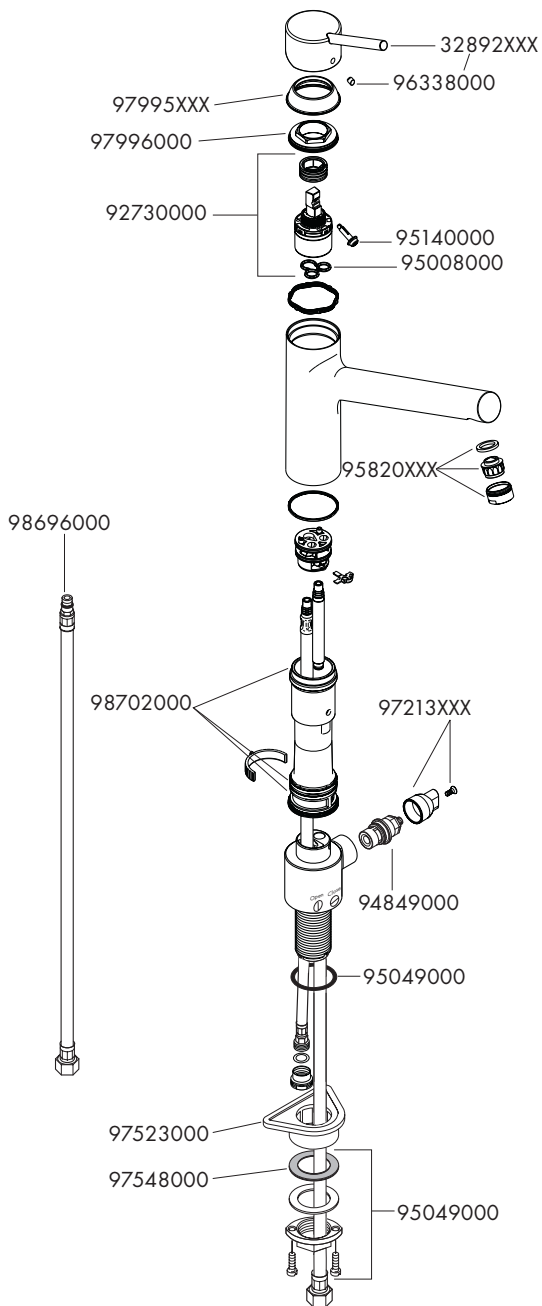

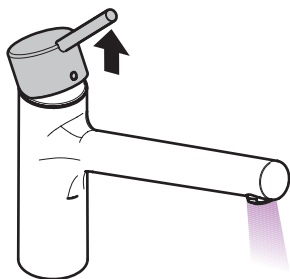

öffnen / ouvert / open / aperto / abierto / open / åbne /  
 abrir / otworzyć / otevřít / otvorit / 开 / открыть / nyitás /  
 avaaaminen / öppna / atidaryti / Otvaranje / açmak /  
 deschide / ανοικτό / odpreti / avage / atvērt /  
 otvoriti / åpne / отварање / hare / فتح

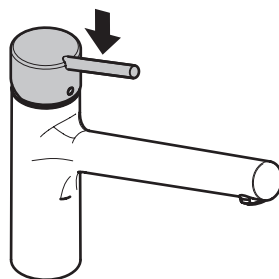

schließen / fermé / close / chiudere / cerrar / sluiten /  
 lukke / fechar / zamknąć / zavřít / uzavriť / 关 /  
 закрыть / bezárás / sulkeminen / stänga / uždaryti /  
 Zatvaranje / kapatmak / închide / κλειστό / zapreti /  
 sulgege / aizvērt / zatvori / lukke / затваряне /  
 mbylle / إغلاق!

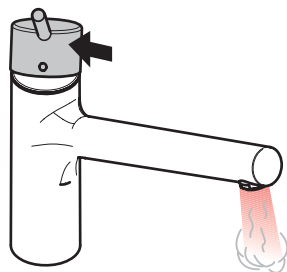

warm / chaud / hot / caldo / caliente / warm / varmt /  
 quente / ciepła / teplá / teplá / 热 / горячая / meleg /  
 lämmin / varmt / karštas / Vruća voda / sıcak / cald /  
 ζεστό / toplo / kuum / karsts / topla / varm / тепло /  
 i ngrohtë / ساخن

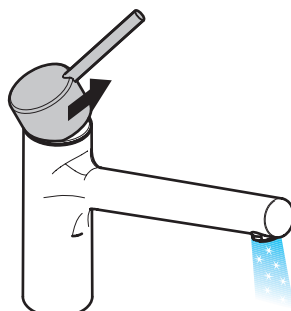

kalt / froid / cold / freddo / frío / koud / koldt / fria /  
 zimna / studená / studená / 冷 / холодная / hideg /  
 kylmä / kallt / šaltas / Hladno / soğuk / reze / κρύο /  
 mrzlo / külm / auksts / hladno / kaldt / студено /  
 i fhohtë / بارد

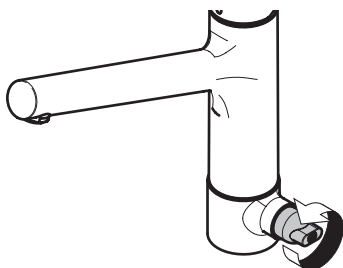

öffnen / ouvert / open / aperto / abierto / open / åbne /  
 abrir / otworzyć / otevřít / otvorit / 开 / открыть / nyitás /  
 avaaaminen / öppna / atidaryti / Otvaranje / açmak /  
 deschide / ανοικτό / odpreti / avage / atvērt /  
 otvoriti / åpne / отварање / hare / فتح

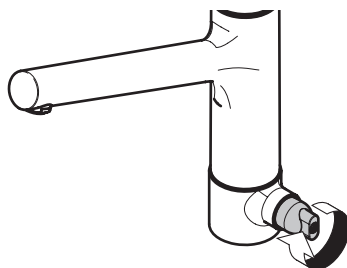

schließen / fermé / close / chiudere / cerrar / sluiten /  
 lukke / fechar / zamknąć / zavřít / uzavriť / 关 /  
 закрыть / bezárás / sulkeminen / stänga / uždaryti /  
 Zatvaranje / kapatmak / închide / κλειστό / zapreti /  
 sulgege / aizvērt / zatvori / lukke / затваряне /  
 mbylle / إغلاق!



	<b>P-IX</b>	<b>DVGW</b>	<b>SVGW</b>	<b>WRAS</b>	<b>KIWA</b>	<b>NF</b>	<b>ACS</b>	<b>ETA</b>
<b>32851XXX</b>	P-IX 18307/IB	BS5027	X	X	X	X	X	1.42/19670
<b>32855XXX</b>	PA-IX 18450/IA			X				1.42/19670

**Talis S**  
32851XXX



**Talis S**  
32855XXX

