

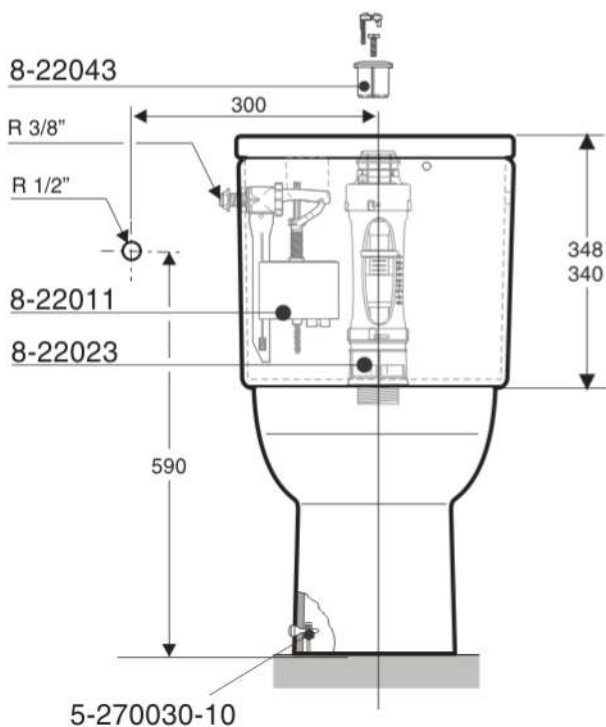

Roca

DAMA SENSO COMPACTO

3-41516 / 3-41519

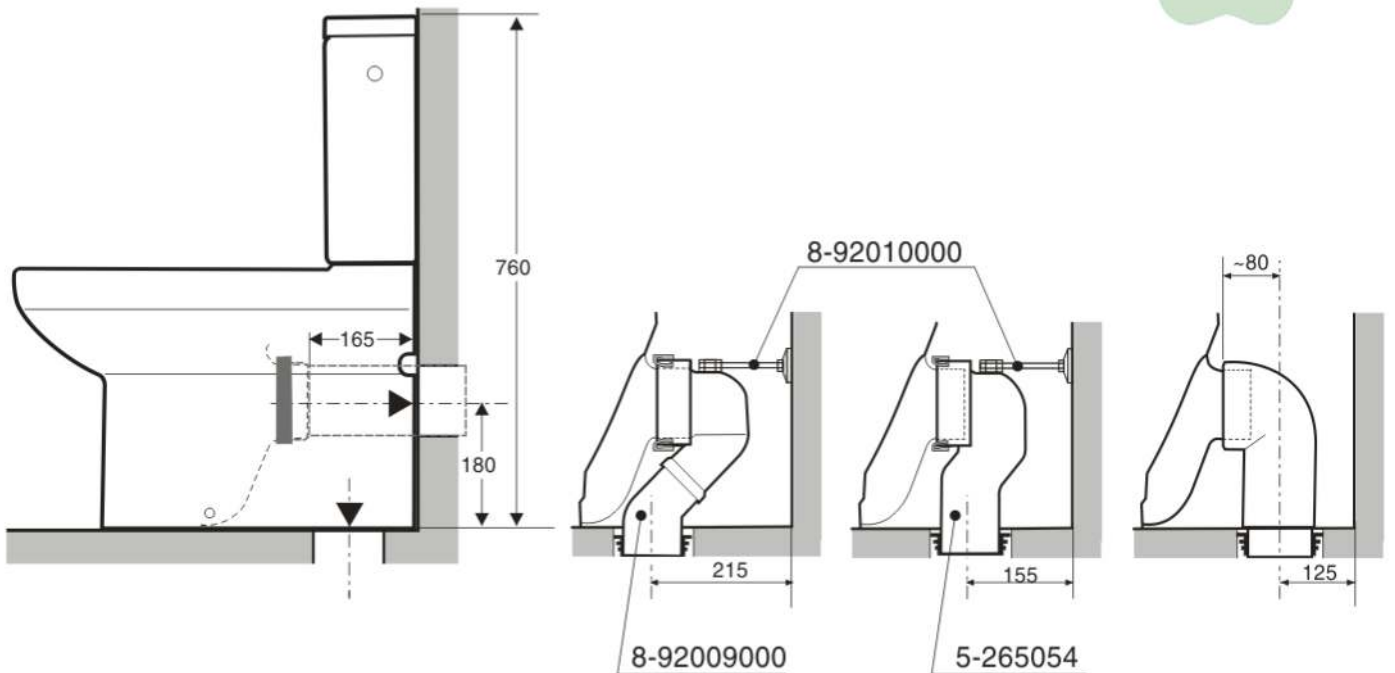
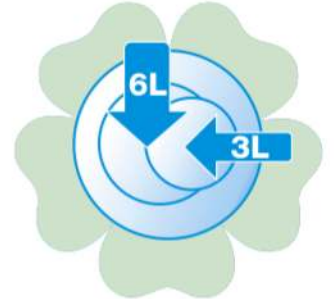

8-22854

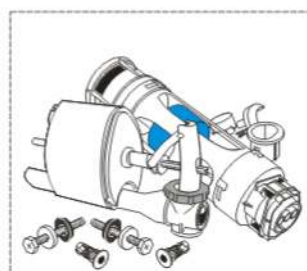

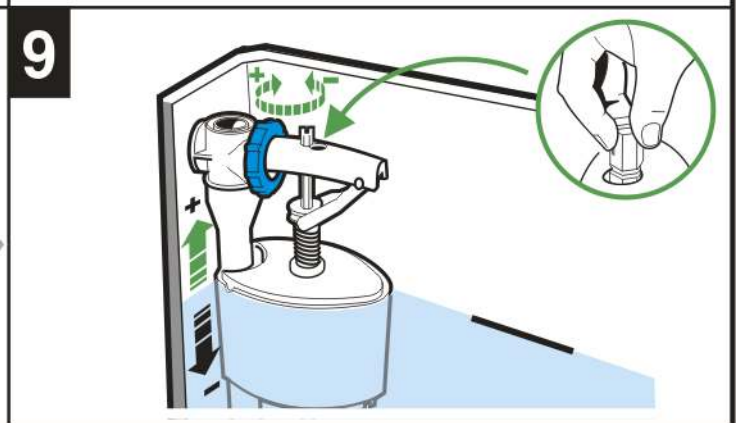
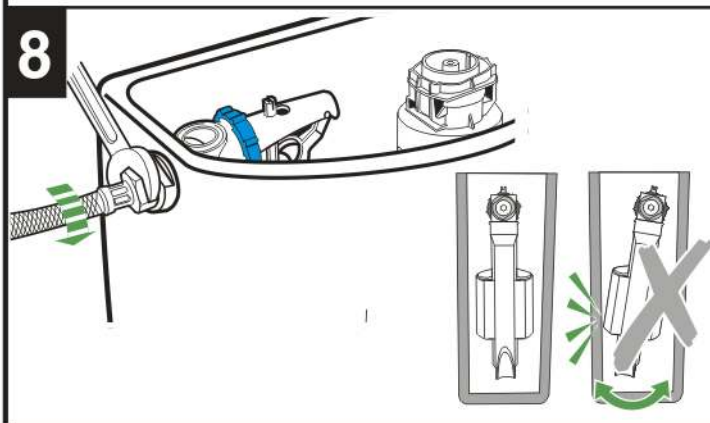
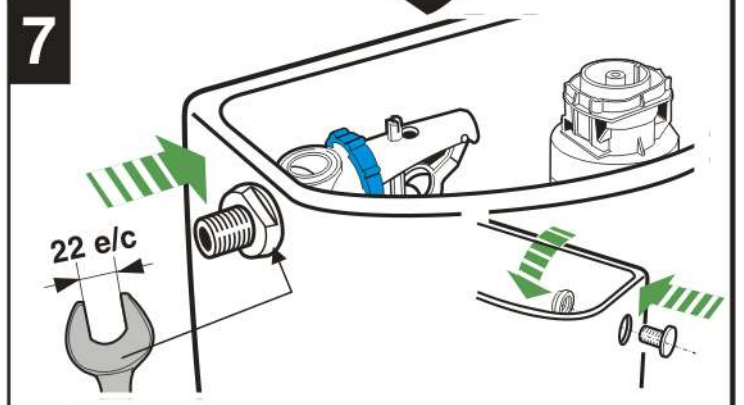
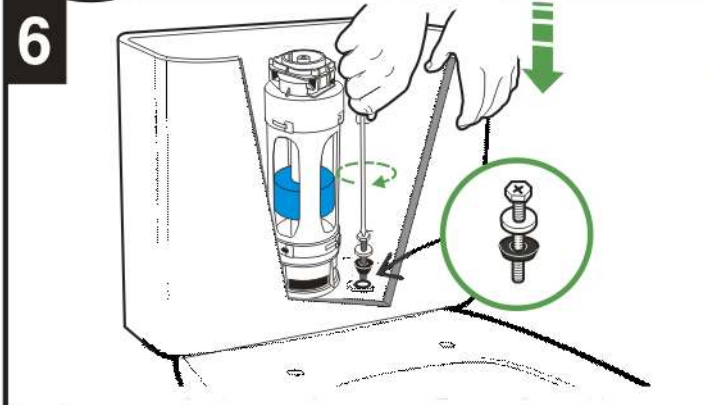
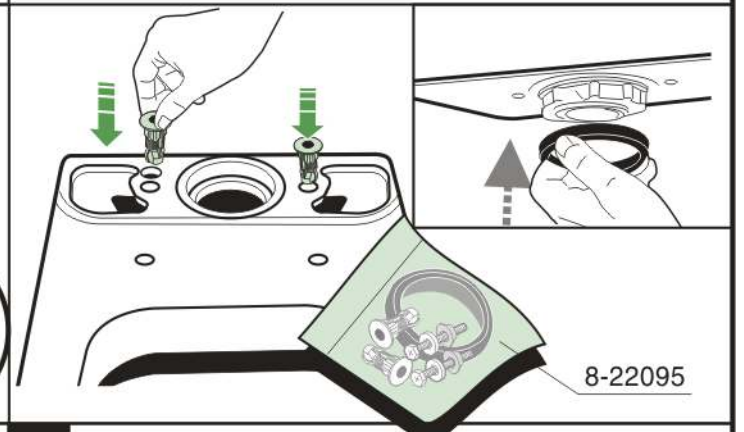
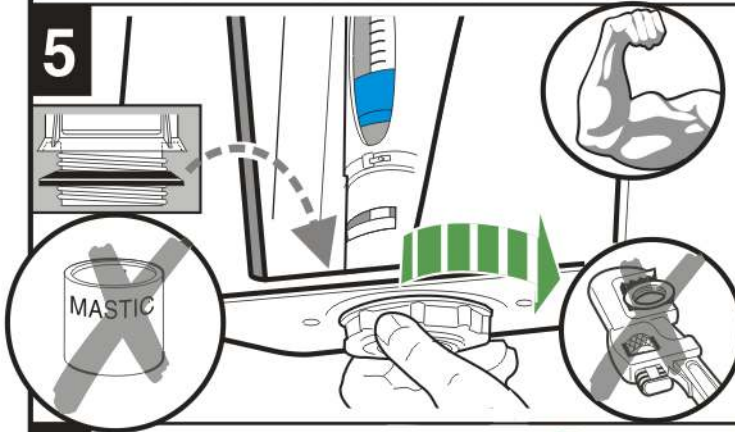
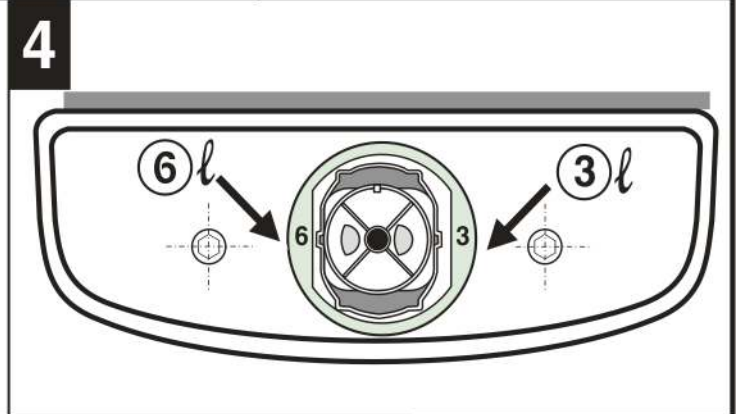
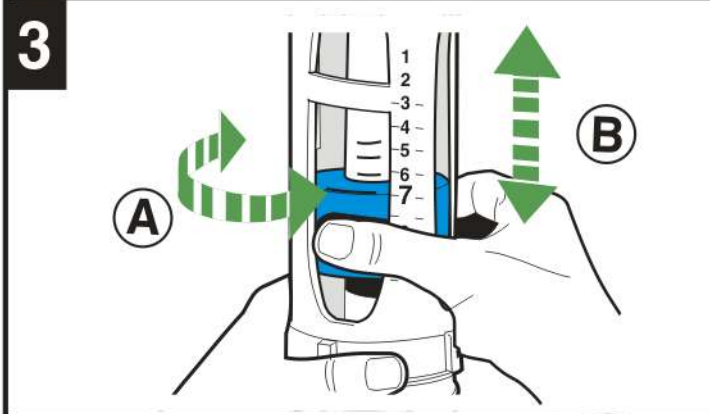
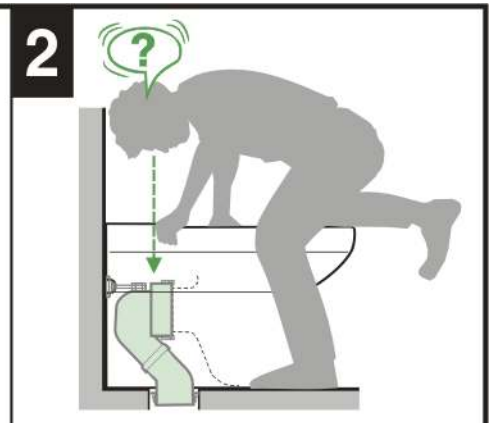
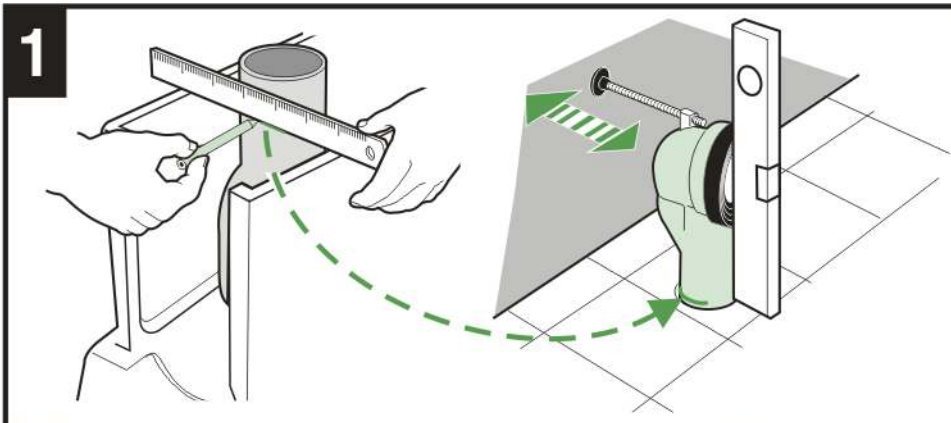

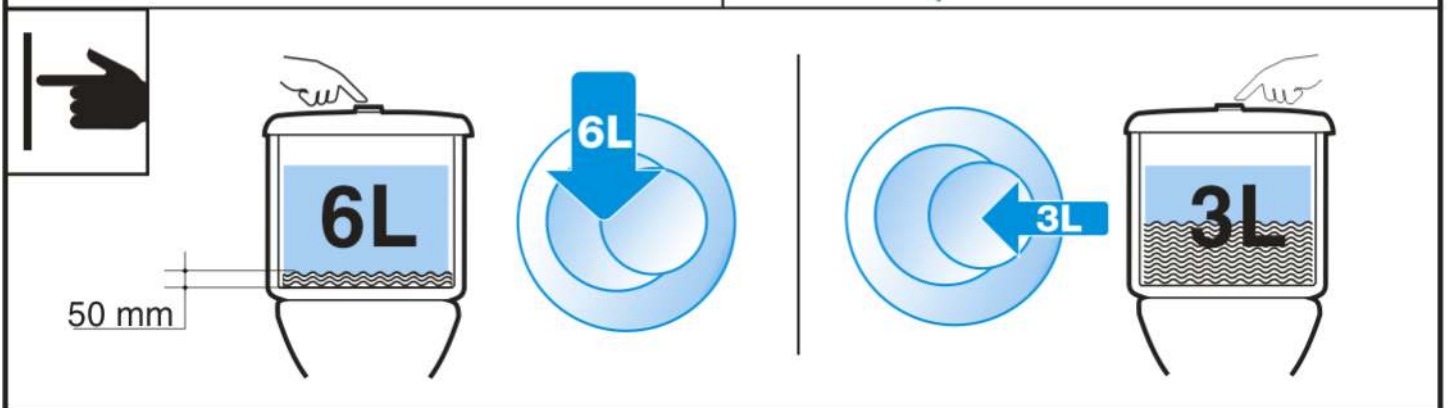
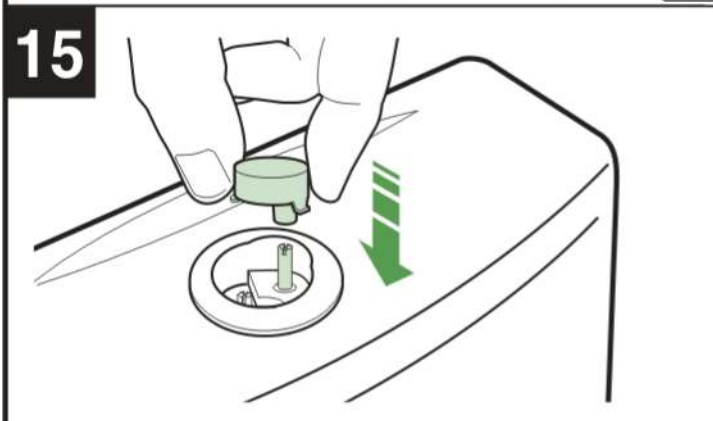
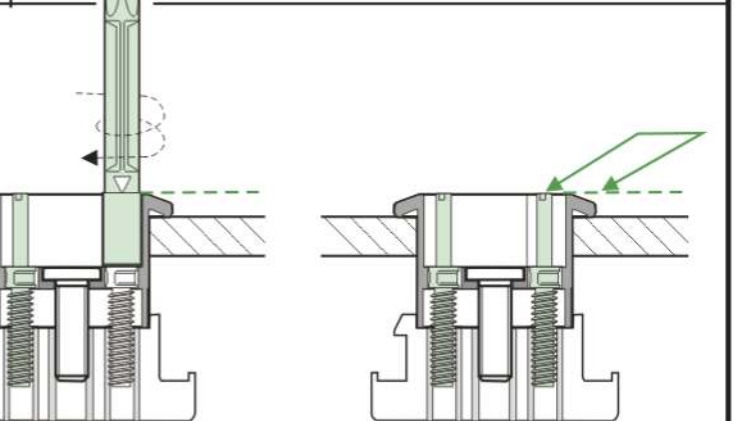
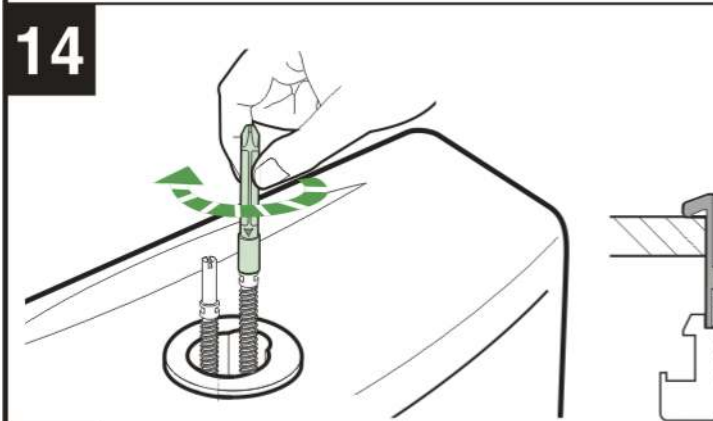
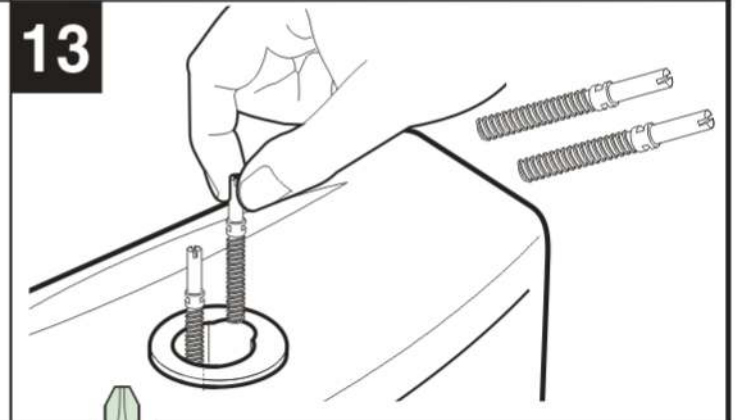
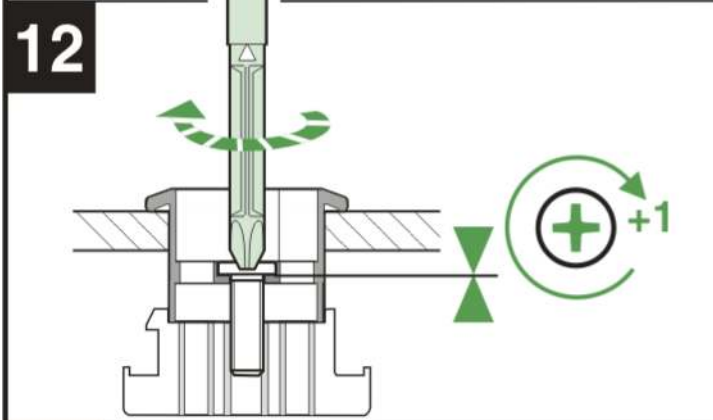
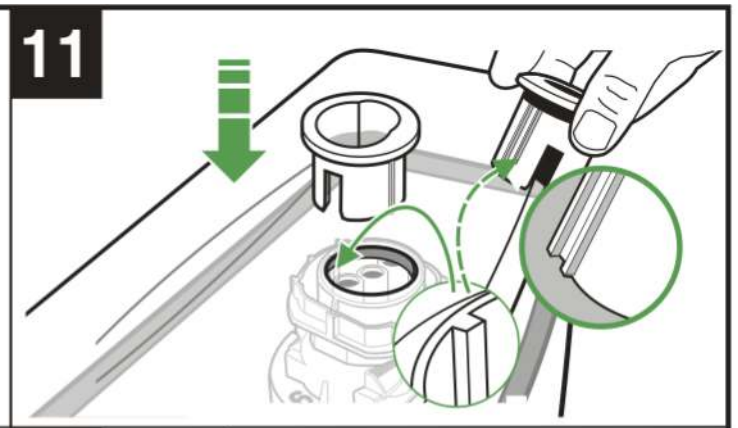
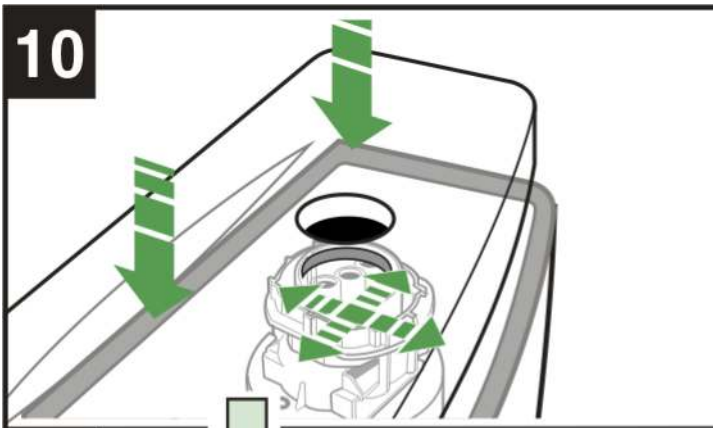

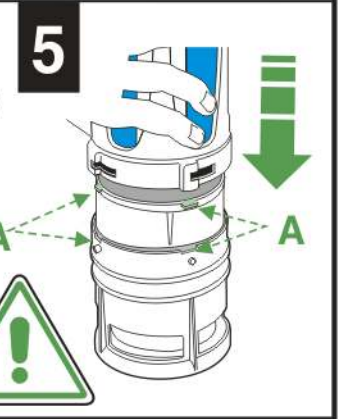
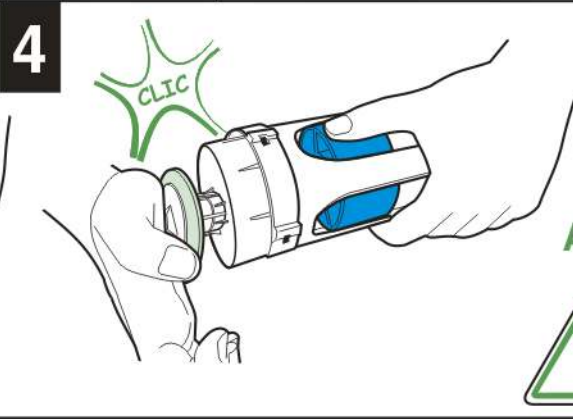
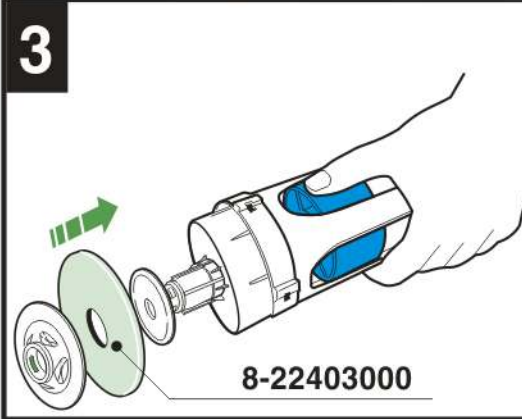
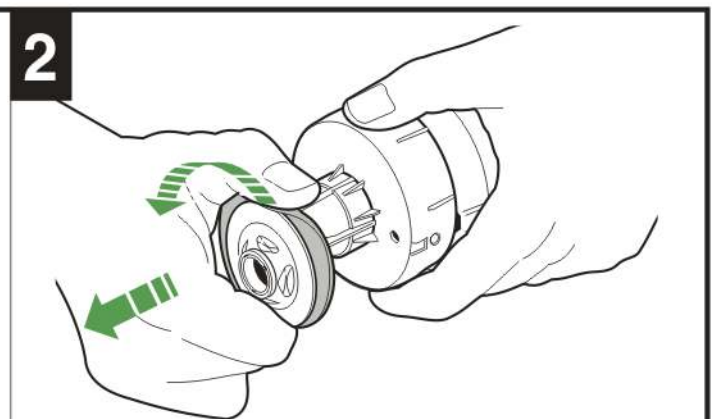
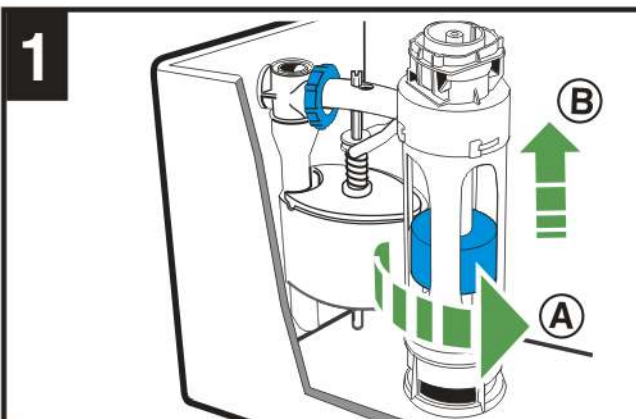
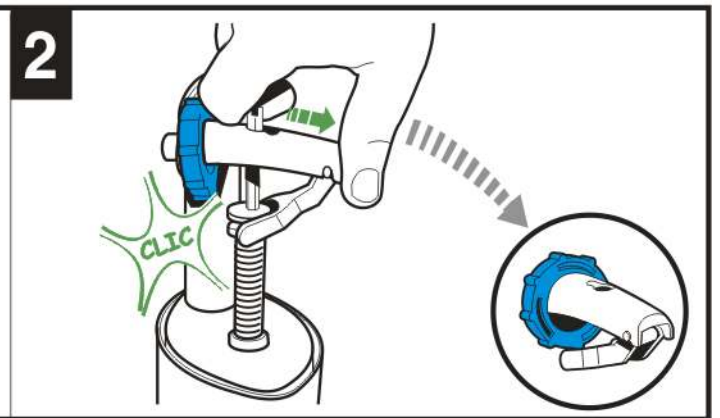
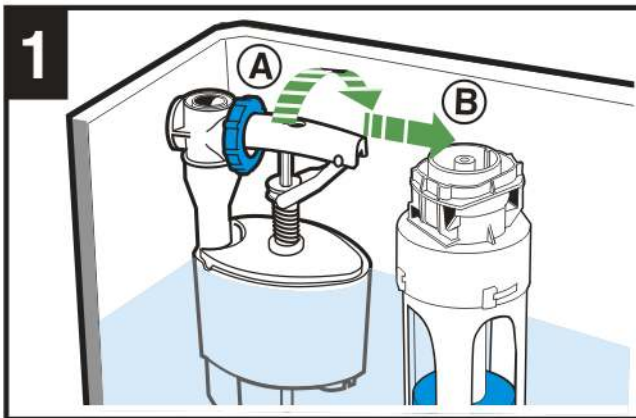
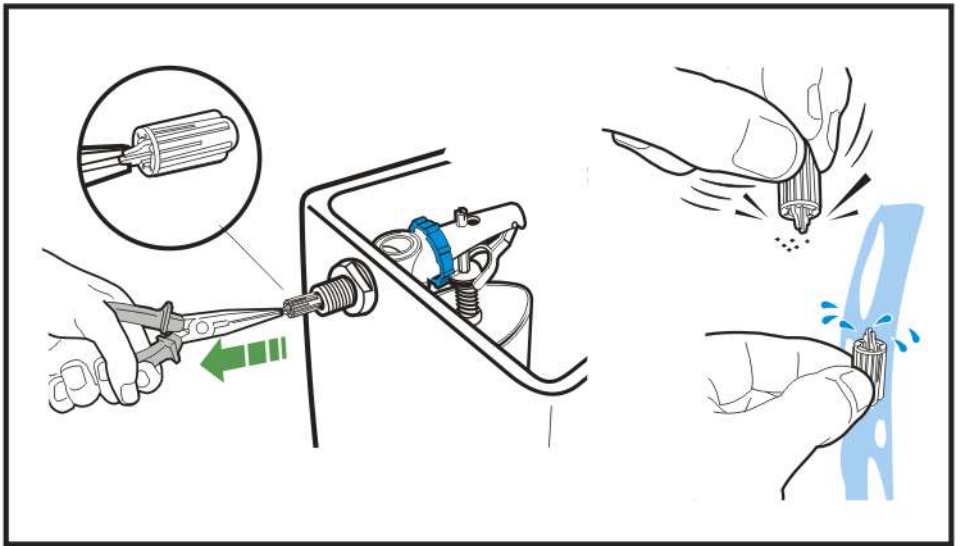
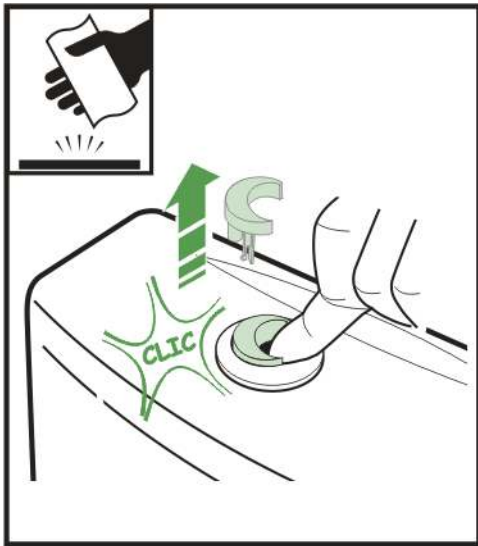

Roca Sanitario, S.A.
 Avda. Diagonal, 513
 08029 Barcelona - SPAIN
 Teléfono 93 366 1200
 Fax 93 419 4501
 www.roca.es



8-22735800C