

KLUDI BINGO STAR

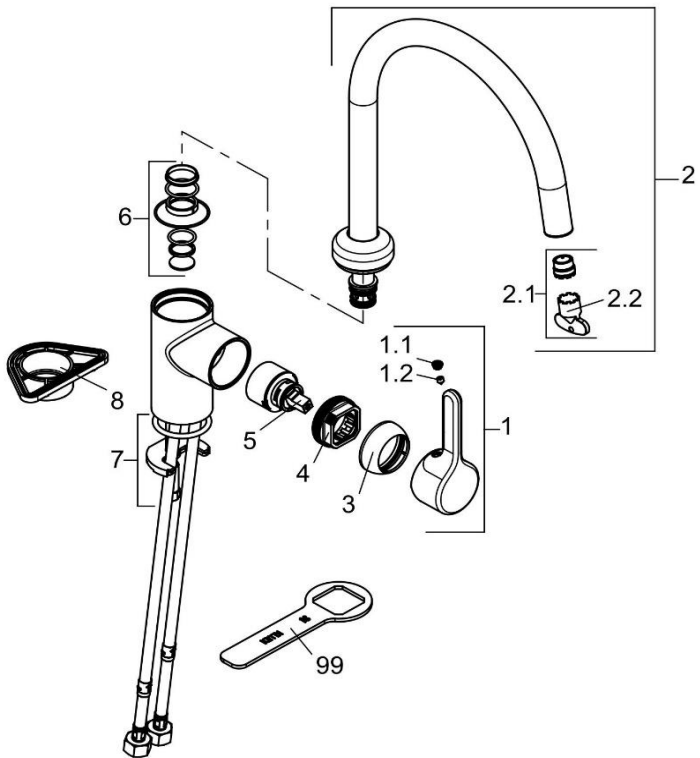

428039678		Spültisch-Einhandmischer DN 15	single lever sink mixer DN 15
1	7303896-00	HEBEL BINGO STAR	LEVER BINGO STAR
1.1	92204601-00	GEWINDESTIFT	GRUB SCREW
1.2	93089705B-00	STOPFEN	PLUG
2	7303996-00	AUSLAUF	SPOUT
2.1	7301700-00	STRAHLREGLER	AERATOR
2.2	93069300-00	STRAHLREGLERSCHLÜSSEL	WRENCH FOR AERATOR
3	93018696-00	ABDECKKAPPE	COVER CAP
4	82311500-00	SPANNSCHRAUBE	FASTENING SCREW
5	7560500-00	STEUEREINHEIT	CERAMIC CARTRIDGE
6	7301900-00	DICHTUNGSSATZ	SEALING SET
7	7433500-00	BEFESTIGUNGSSATZ	MOUNTING KIT
8	93001600-00	VERSTÄRKUNGSPLATTE	STABILIZER PLATE
99	92907700-00	SPANNSCHRAUBENSCHLÜSSEL	WRENCH FOR FASTENING SCREW