

KLUDI BALANCE

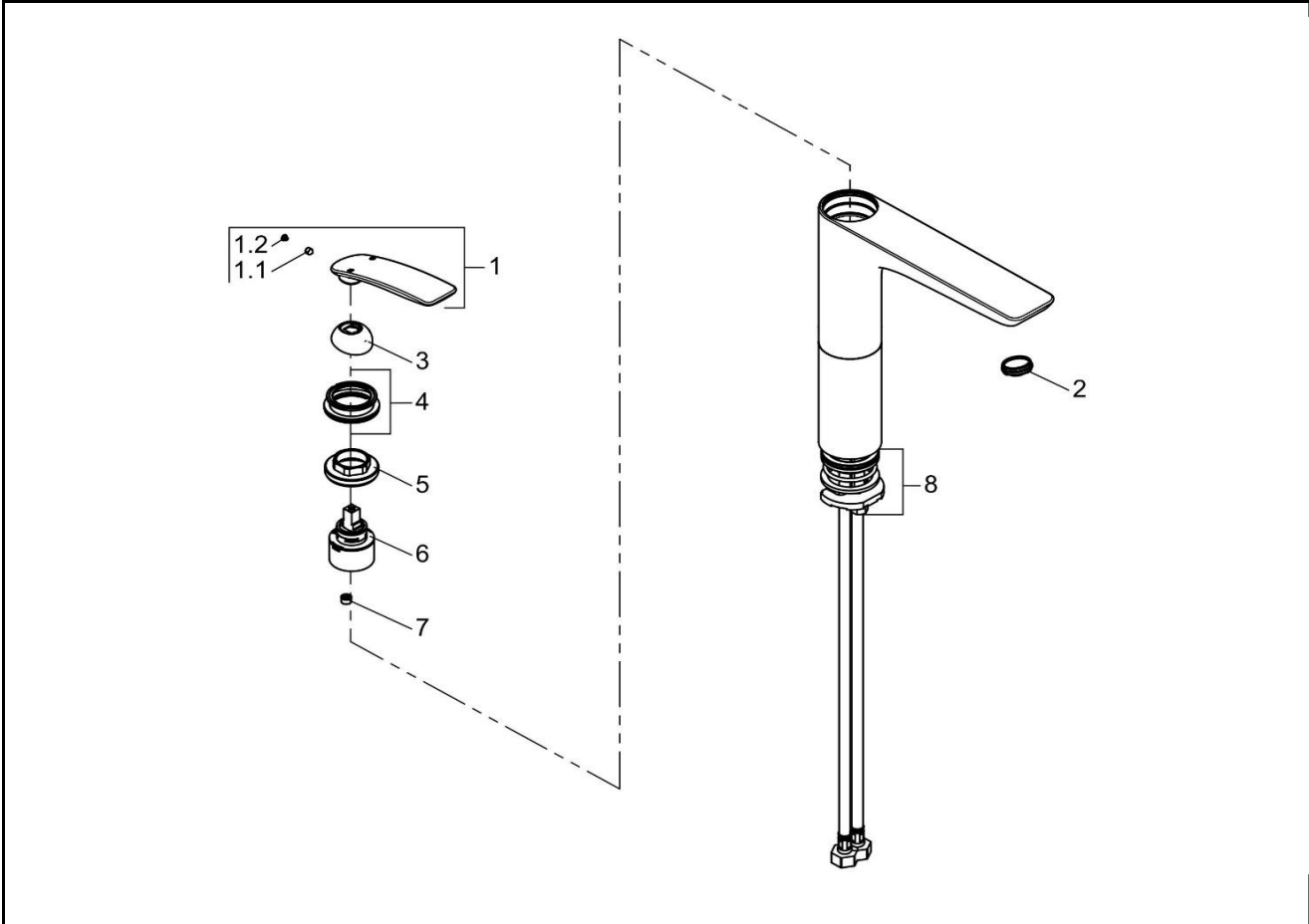

522968775		Waschtisch-Einhandmischer DN 15	single lever basin mixer DN 15
1	7498939-00	HEBEL BALANCE	LEVER BALANCE
1.1	92204601-00	GEWINDESTIFT	GRUB SCREW
1.2	7488700-00	STOPFEN	PLUG
2	7417900-00	STRAHLREGLER	AERATOR
3	93009705-00	ABDECKKAPPE	COVER CAP
4	7473005-00	ABDECKKAPPE	COVER CAP
5	92200737-00	SPANNSCHRAUBE	FASTENING SCREW
6	7560500-00	STEUEREINHEIT	CERAMIC CARTRIDGE
7	7484100-00	MENGENREGLER	FLOW REGULATOR
8	7459400-00	BEFESTIGUNGSSATZ	MOUNTING KIT