

# Installation

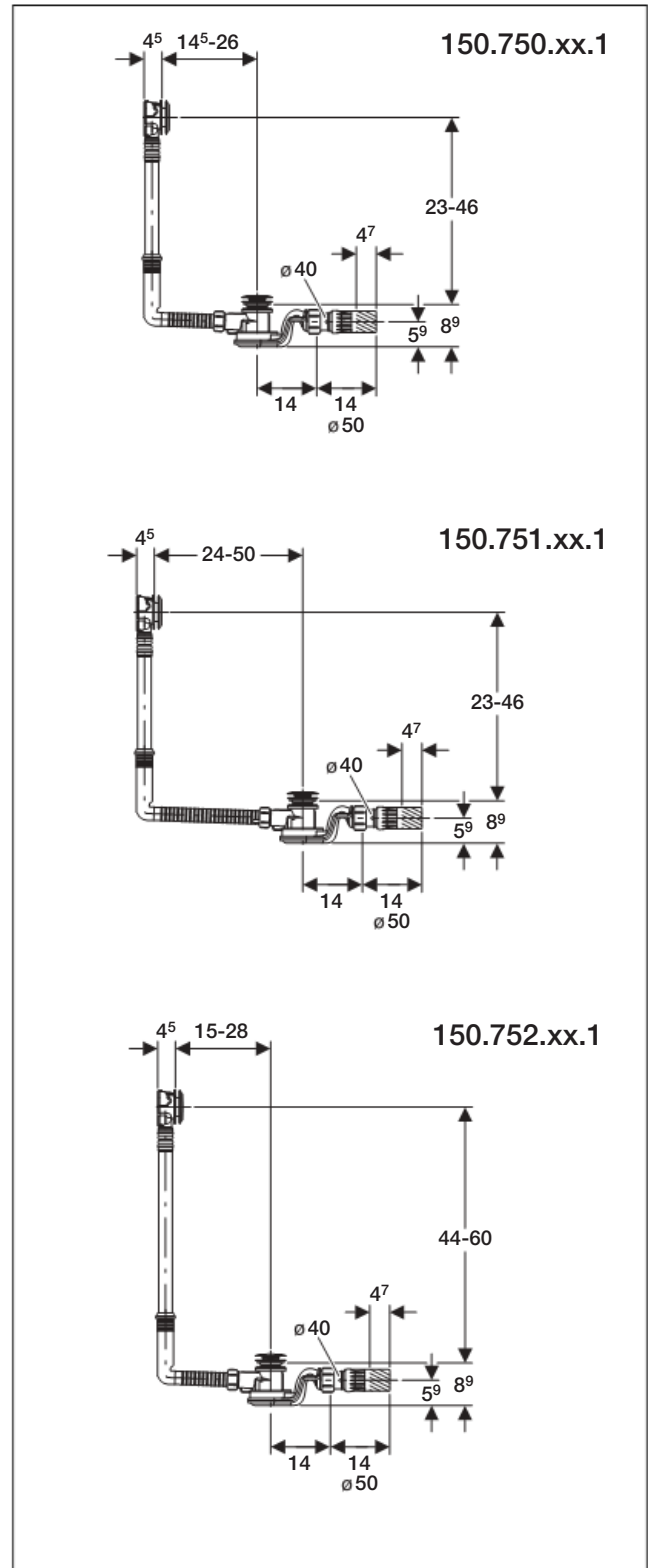

D17909-003&BDC © 12-2007

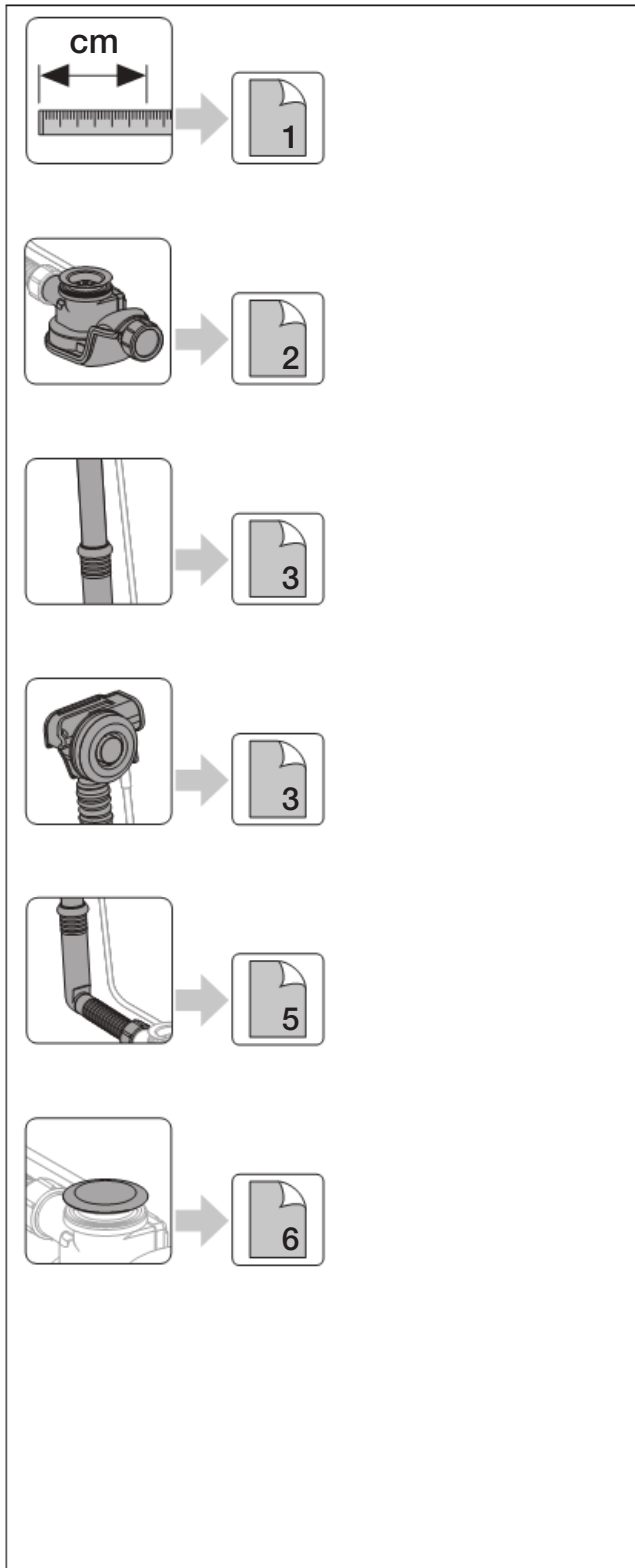

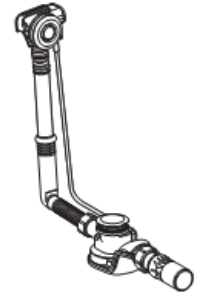
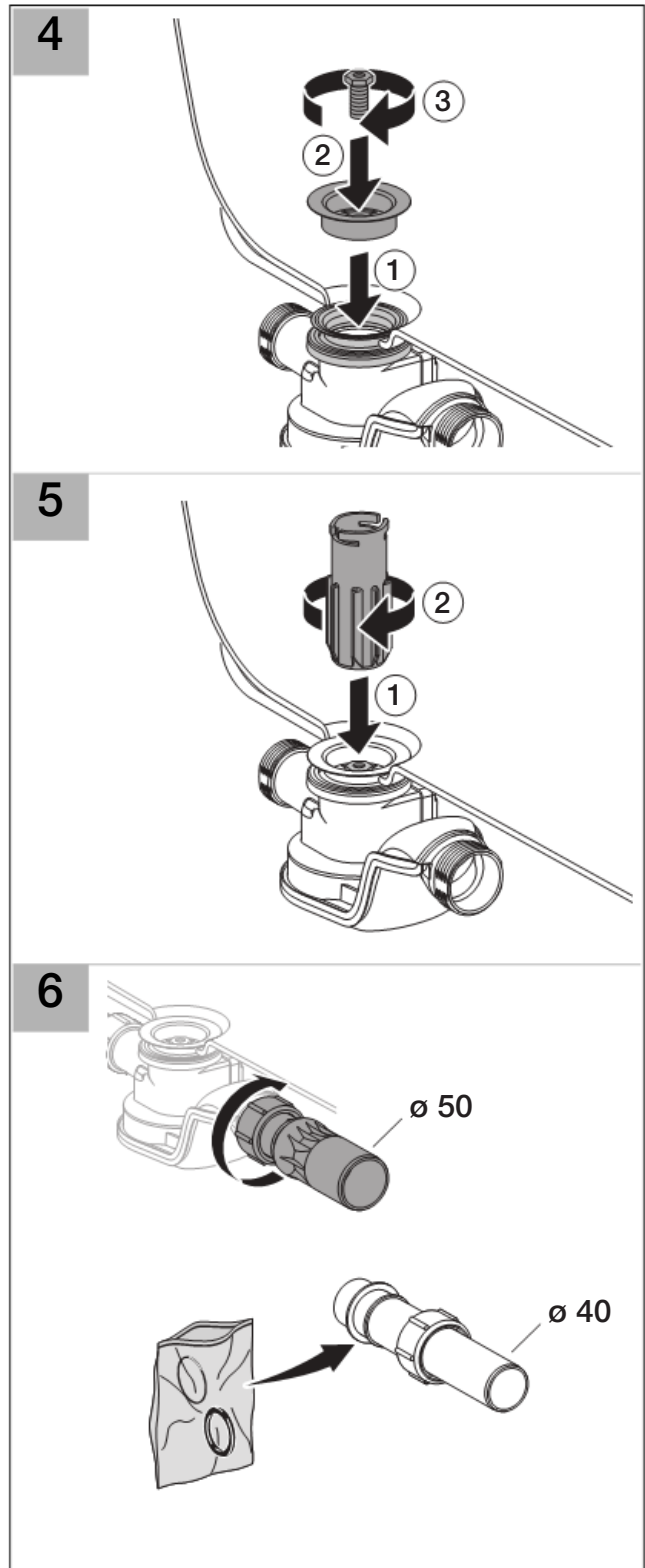
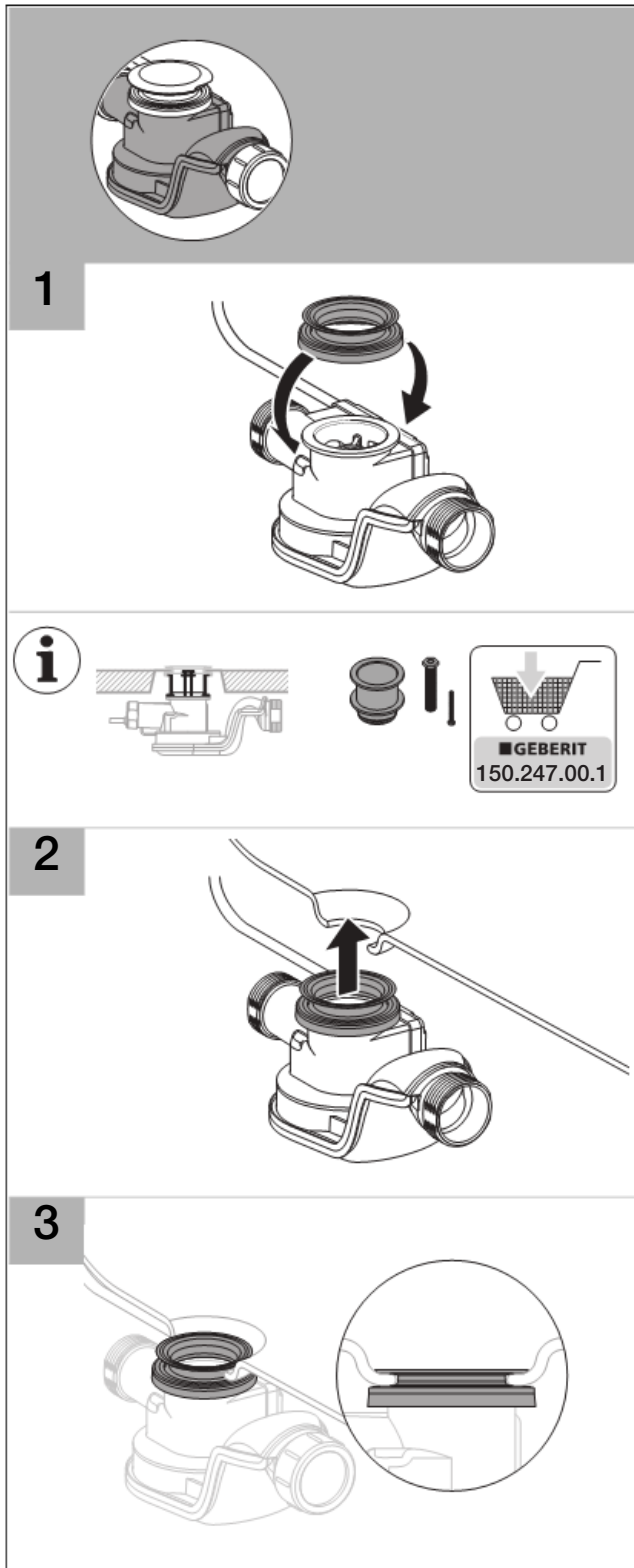
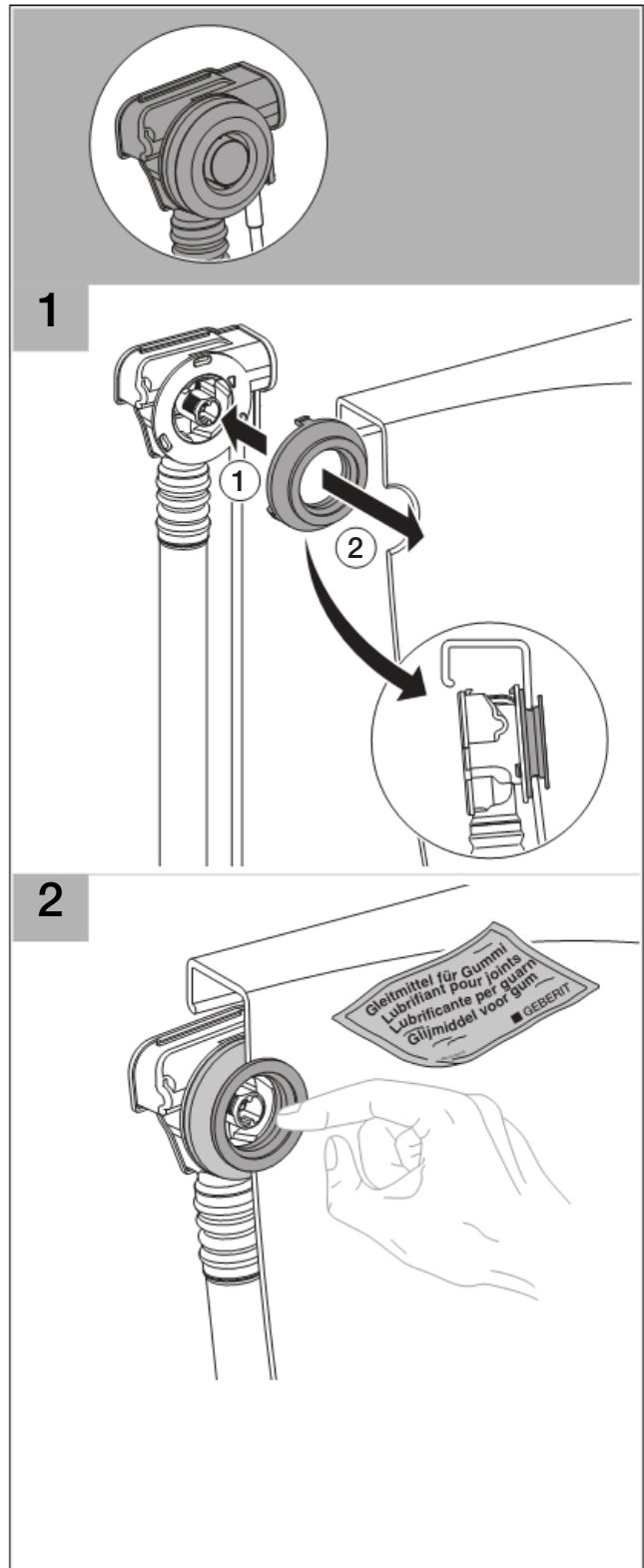
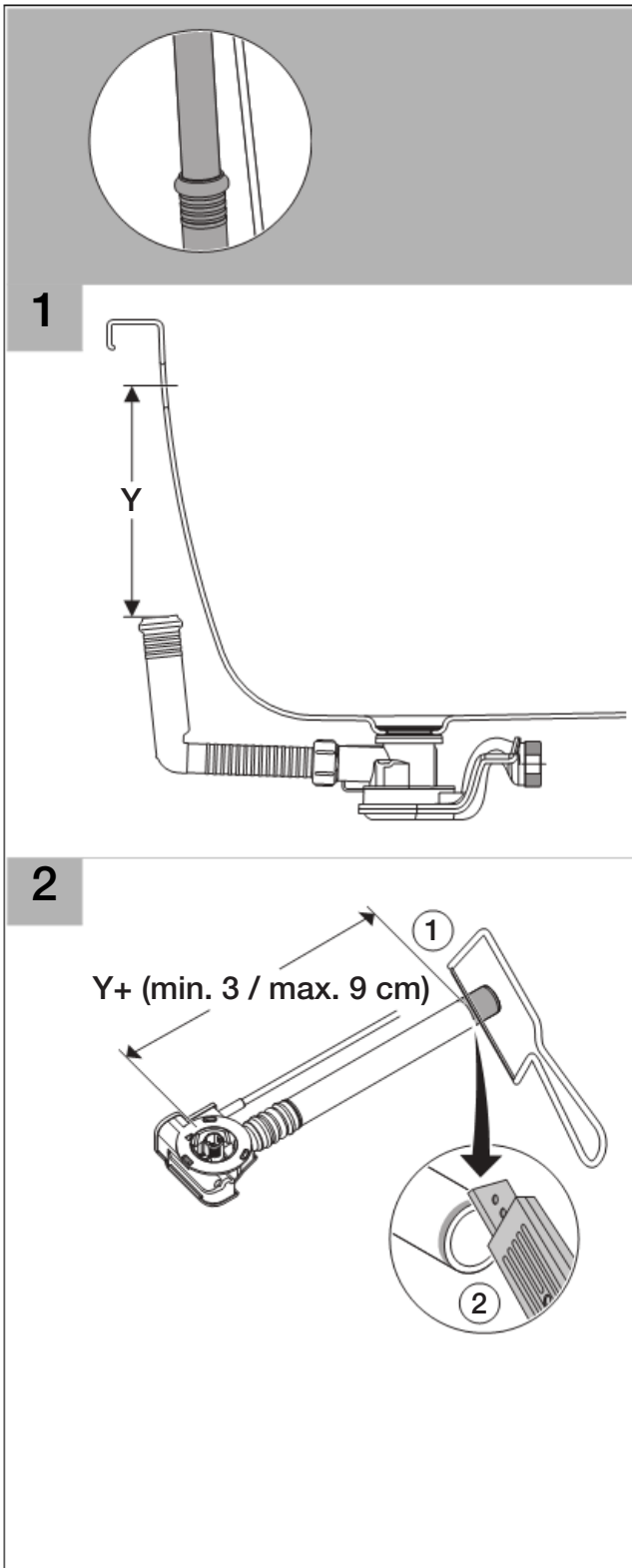

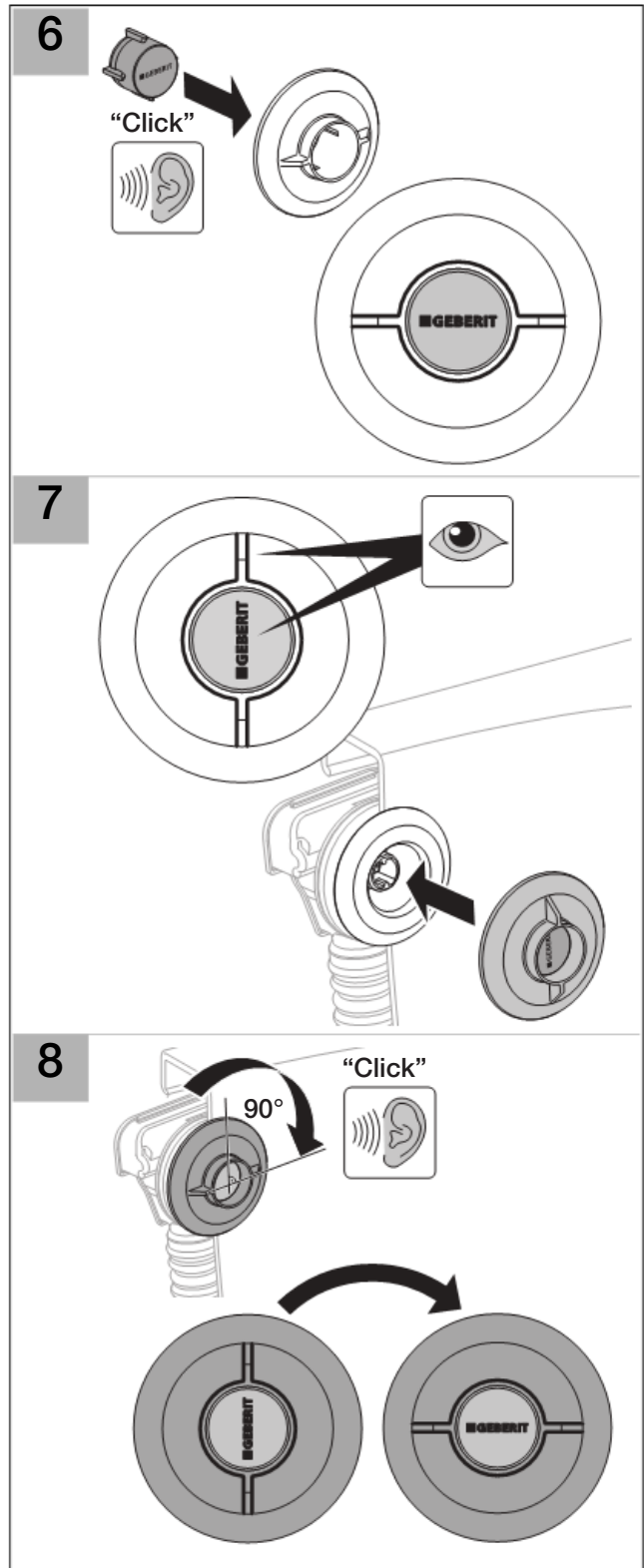
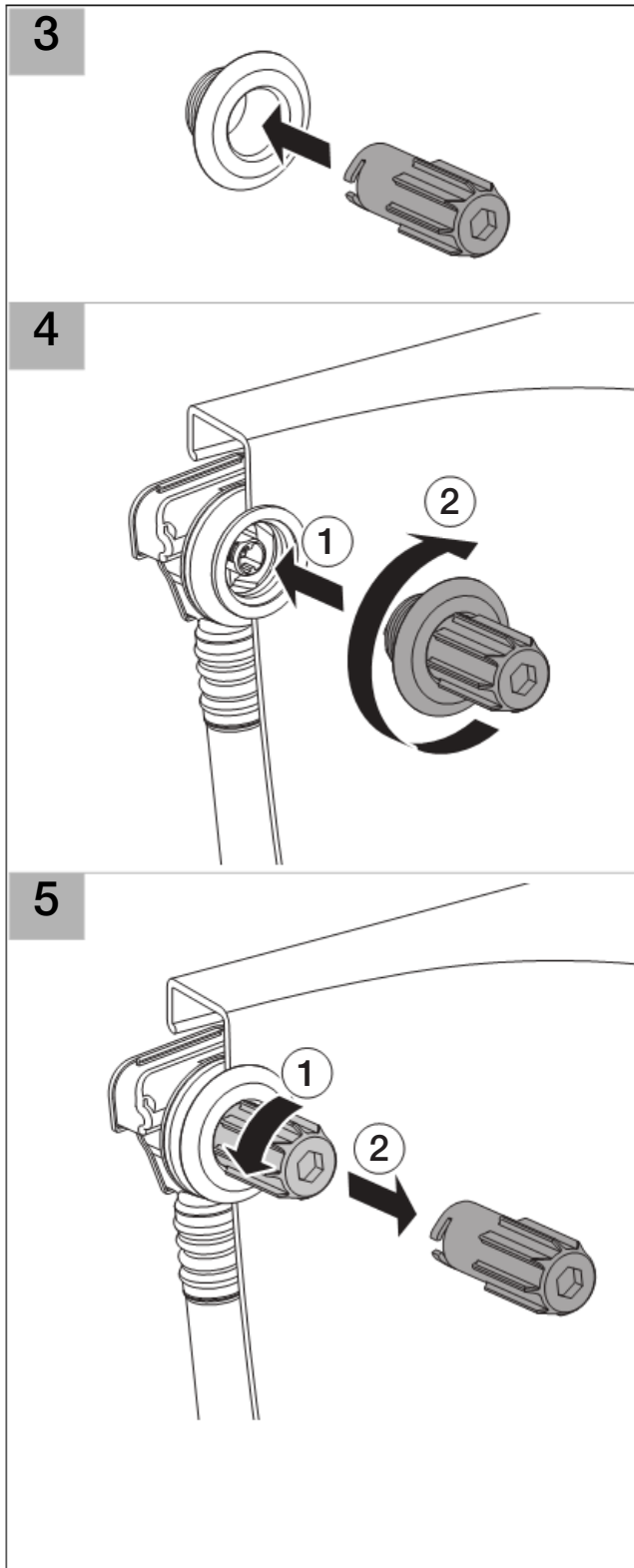

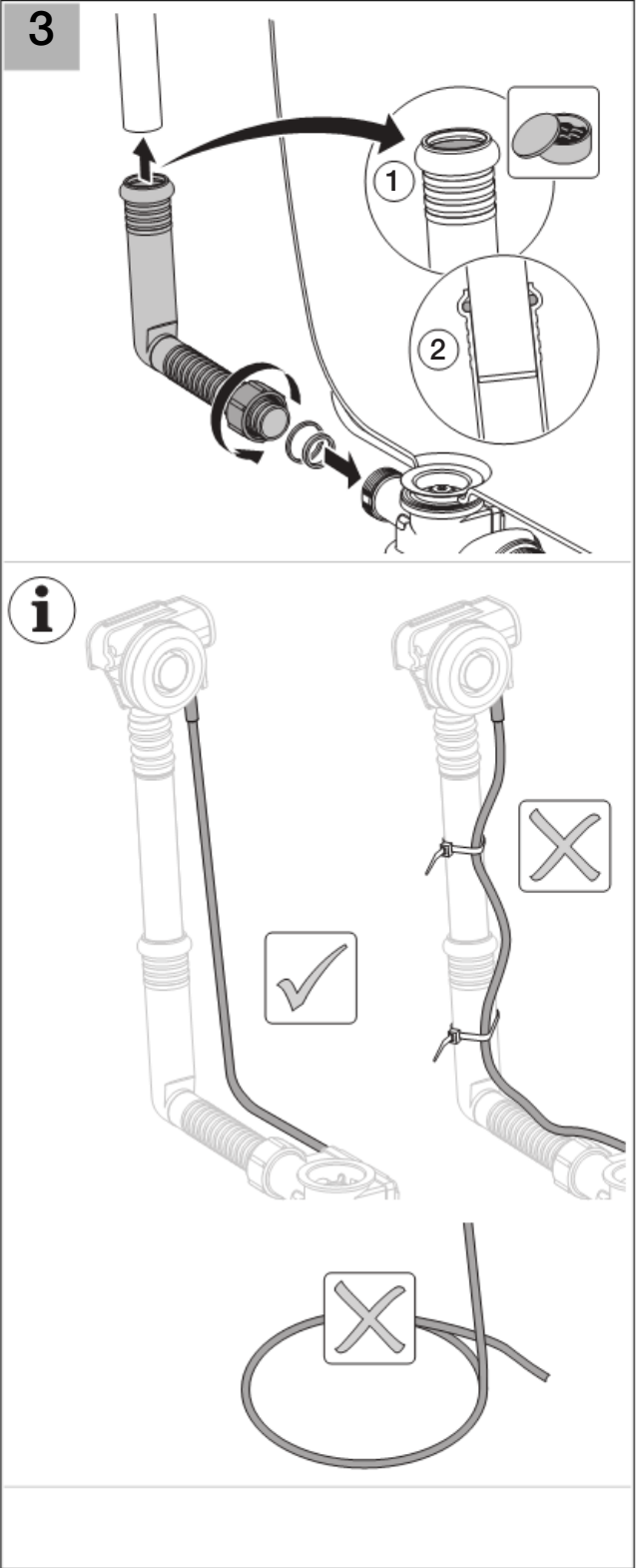
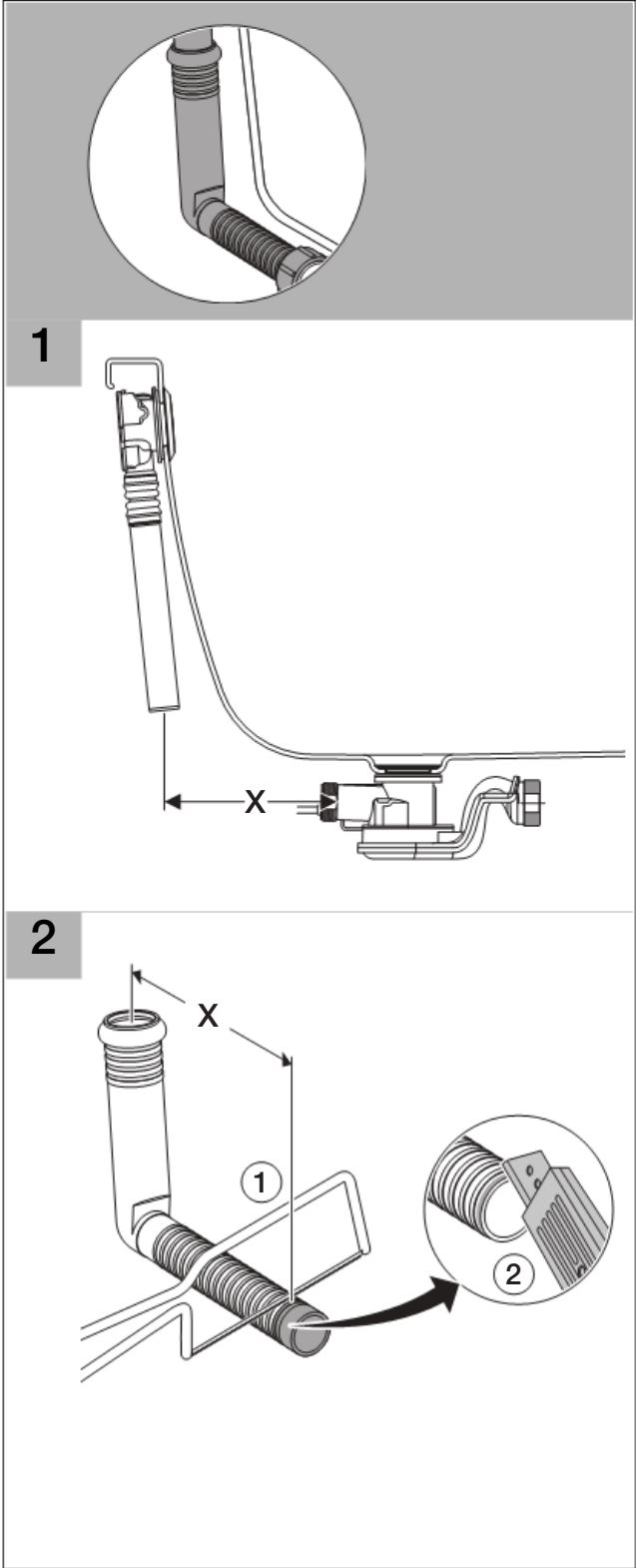

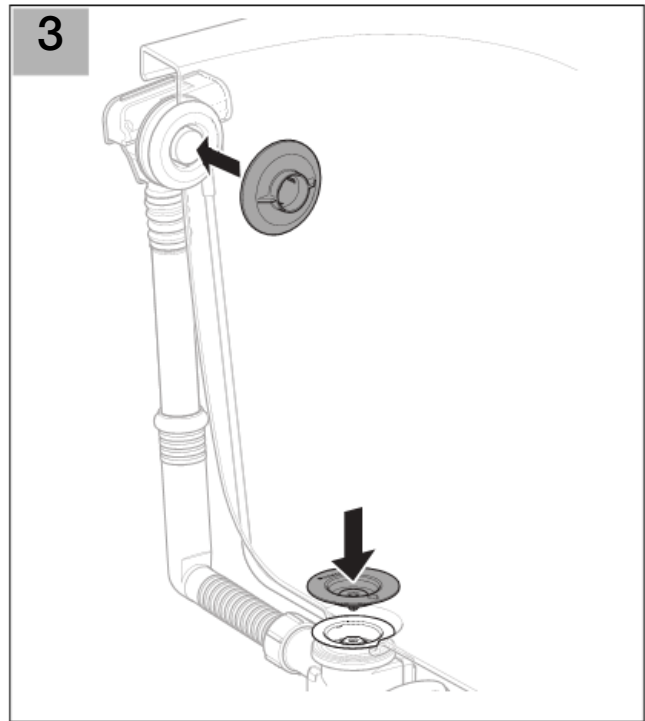
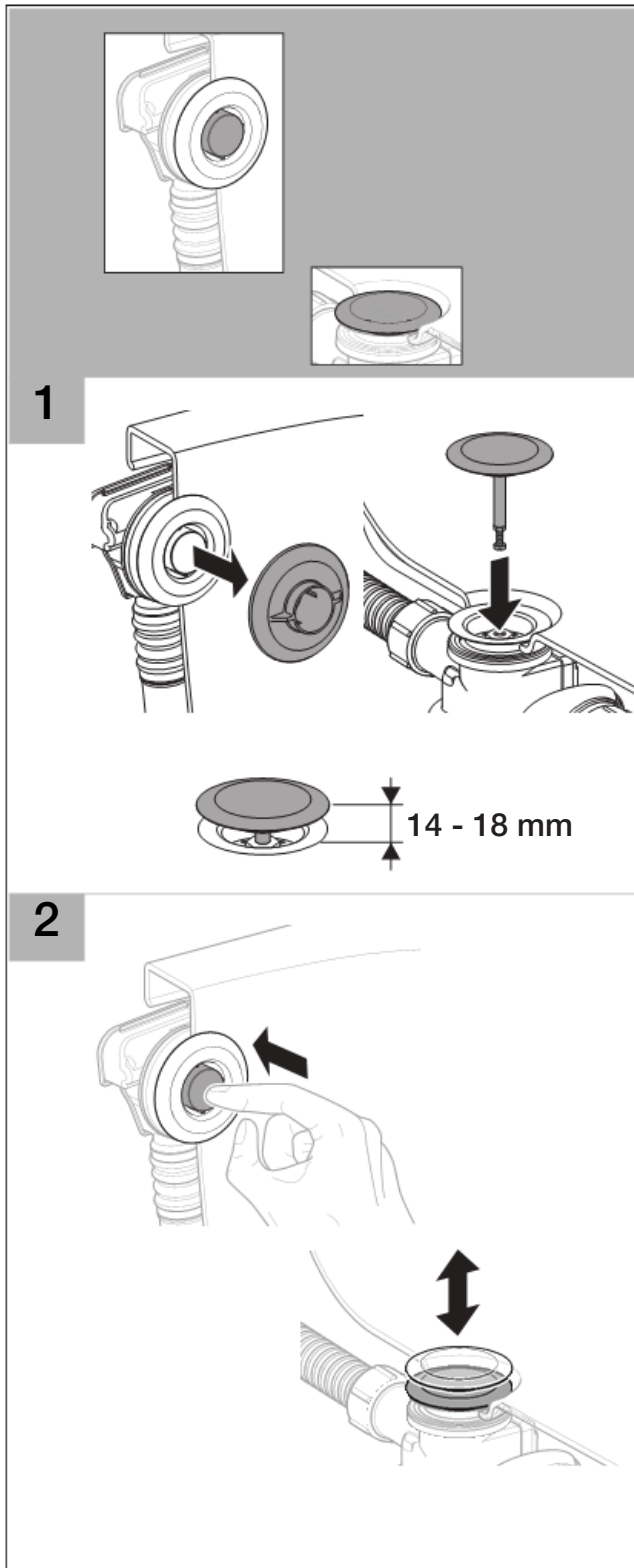

Geberit International AG  
Schachenstrasse 77  
CH-8645 Jona  
[www.geberit.com](http://www.geberit.com)  
[dokumentation@geberit.com](mailto:dokumentation@geberit.com)

D17909-003&BDC © 12-2007