

# CREA

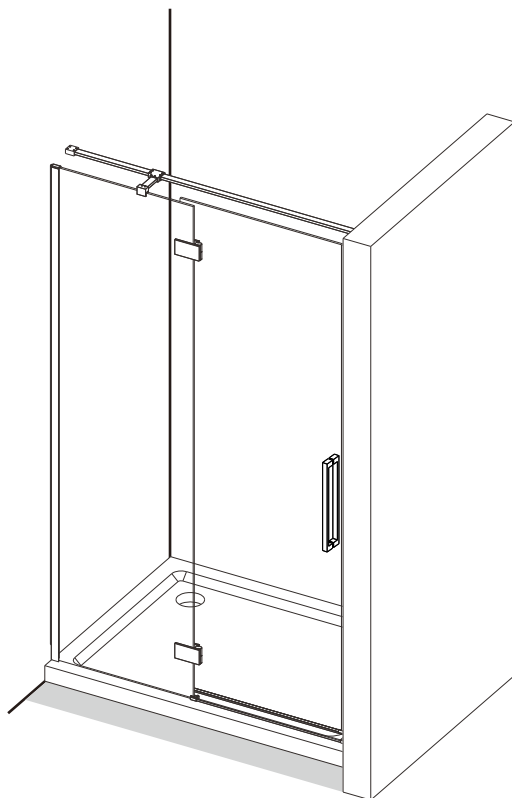

PL INSTRUKCJA MONTAŻU I EKSPLOATACJI

CZ NÁVOD NA MONTÁŽ A ÚDRŽBU

SK NÁVOD NA MONTÁŽ A ÚDRŽBU

EST PAIGALDUS- JA KASUTUSJUHEND

LT MONTAVIMO IR EKSPLOATAVIMO INSTRUKCIJA

LV MONTĀŽAS UN EKSPLUATĀCIJAS INSTRUKCIJA

DE MONTAGE- UND AUFBAUANLEITUNG

RO INSTRUCȚIUNI DE MONTAJ ȘI OPERARE

HU SZERELÉSI ÉS ÜZEMELTETÉSI ÚTMUTATÓ

UA ІНСТРУКЦІЯ З МОНТАЖУ І ЕКСПЛУАТАЦІЇ

BY ІНСТРУКЦЫЯ ПА МАНТАЖЫ І ЭКСПЛУАТАЦЫІ

RU ИНСТРУКЦИЯ ПО МОНТАЖУ И ЭКСПЛУАТАЦИИ

EN INSTRUCTIONS FOR ASSEMBLY AND USE

FR INSTALLATION ET UTILISATION - MODE

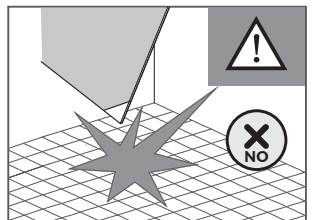
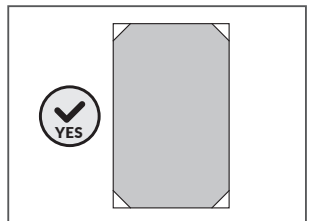
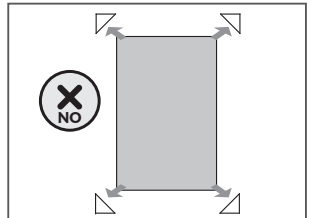
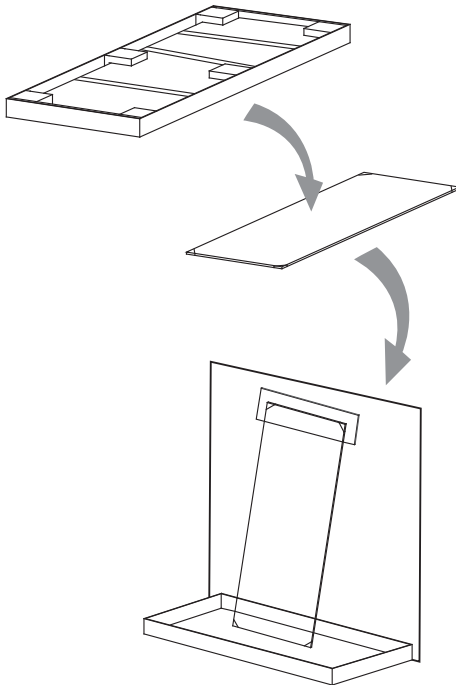
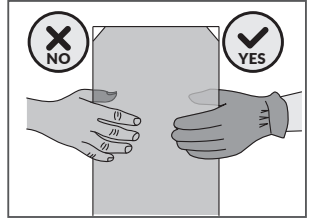
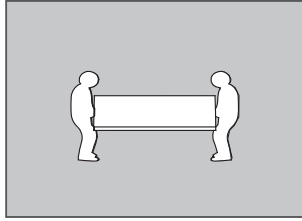
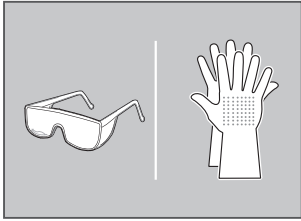
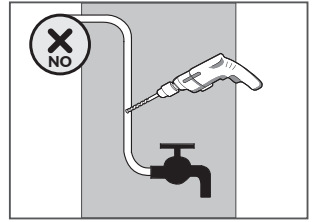
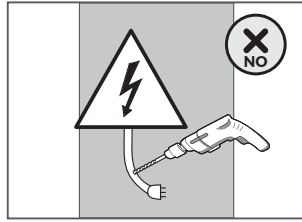
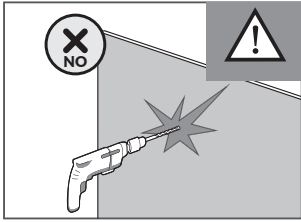

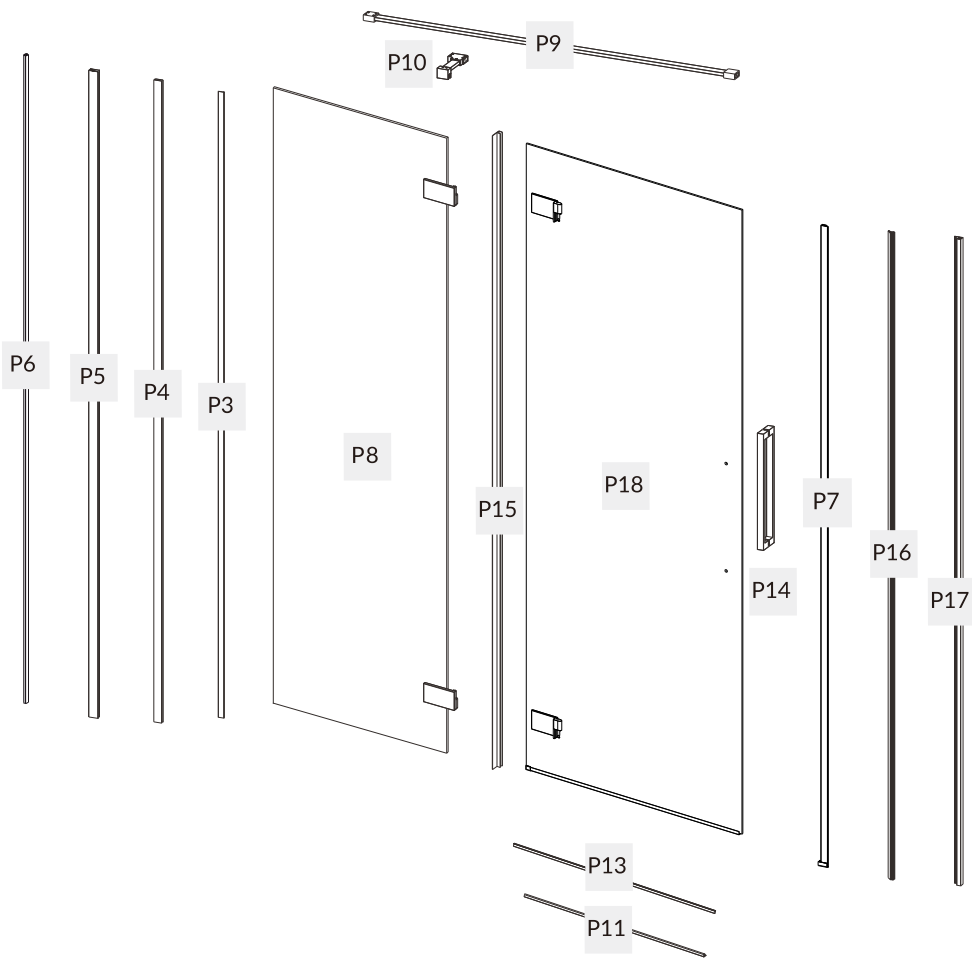

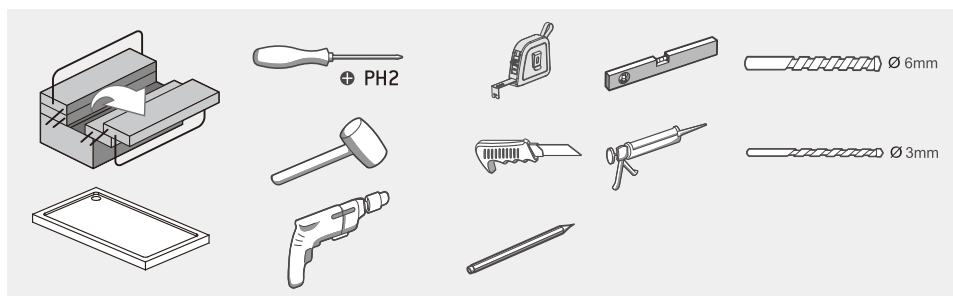
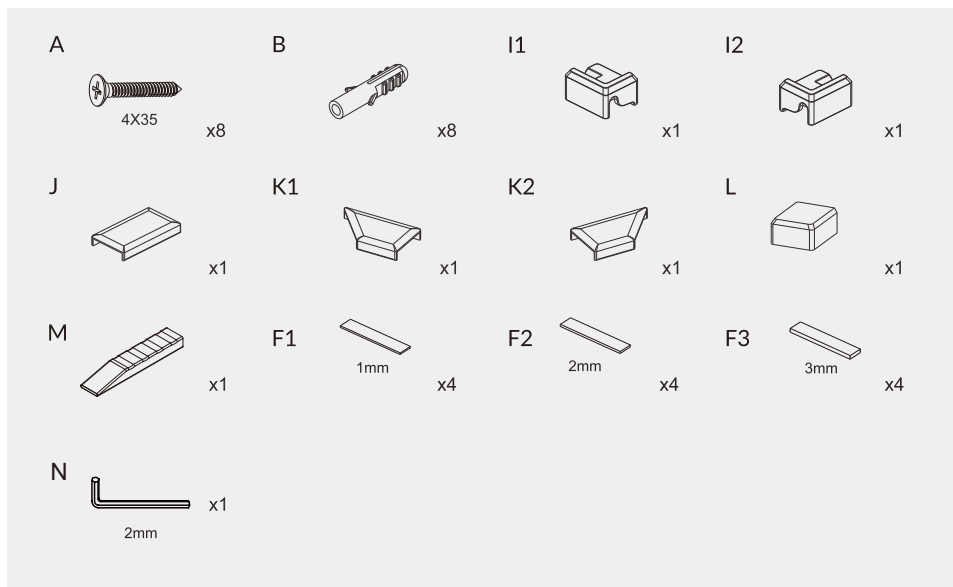

1.

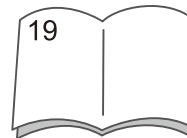
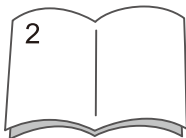
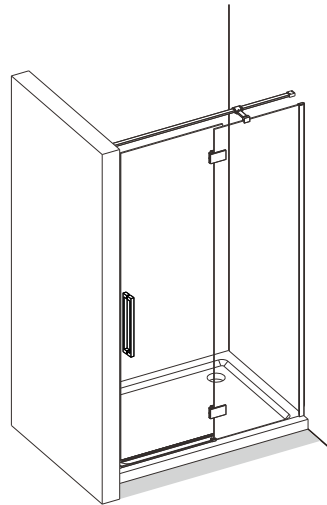
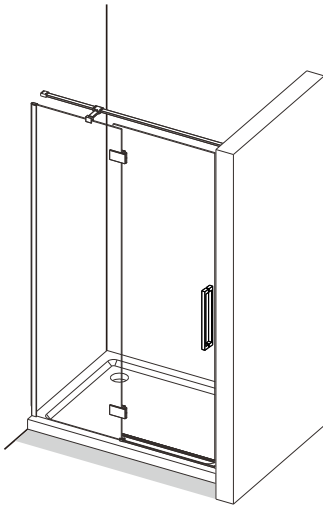

## 2.

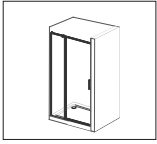

SIZE	X(mm)
900×2000	890-900
1000×2000	990-1000
1200×2000	1190-1200

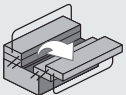
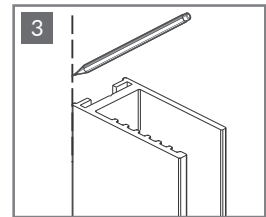
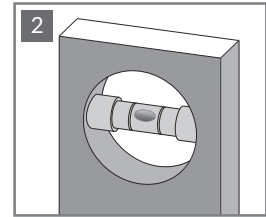
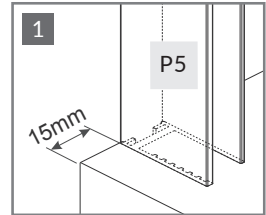
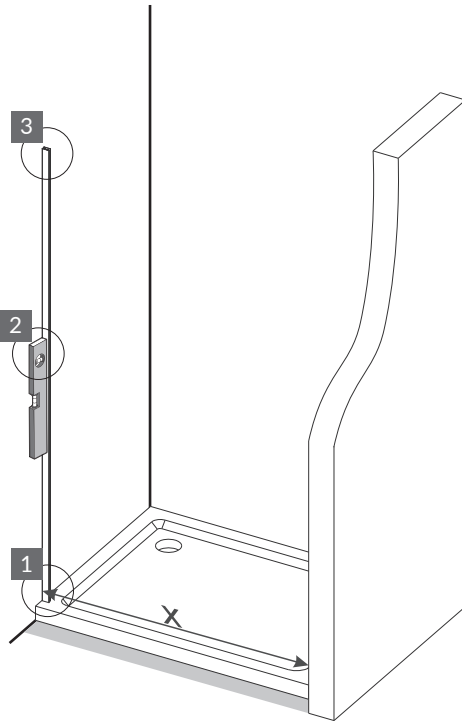

P5



x1



### 3.

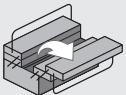
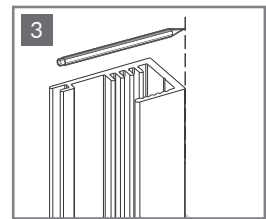
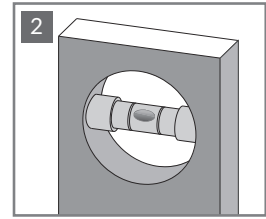
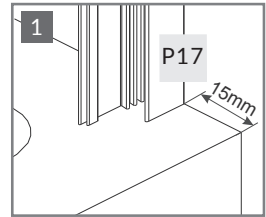
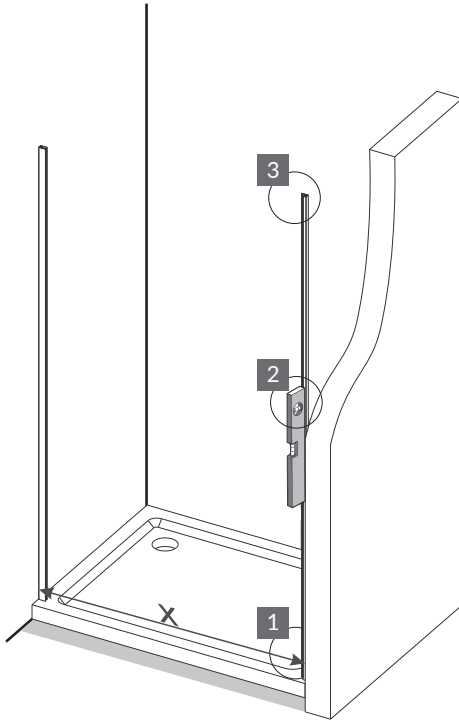
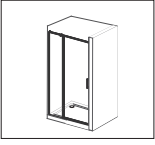

P17



x1



4.

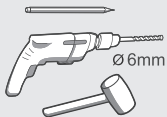
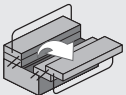
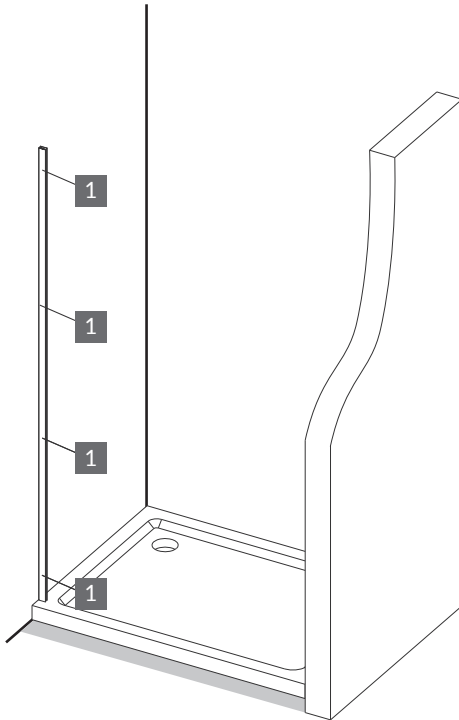
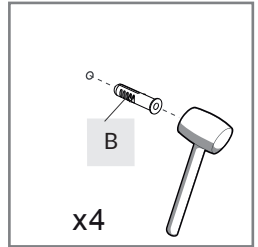
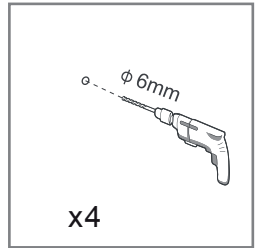
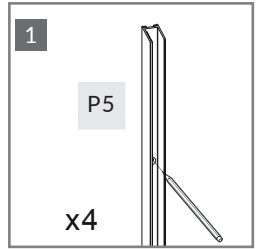
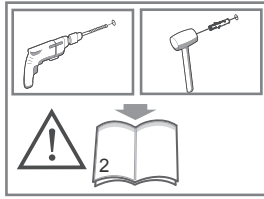
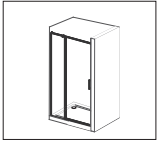

B



x4





# 5.

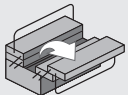
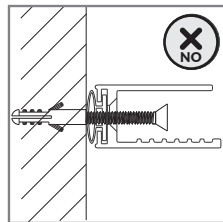
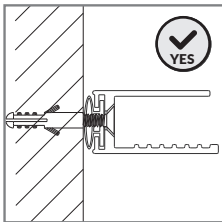
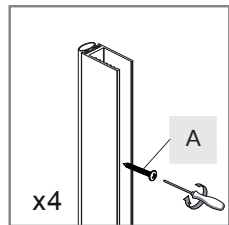
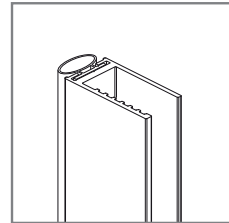
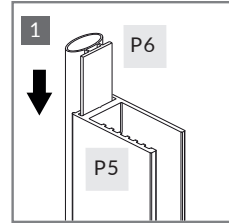
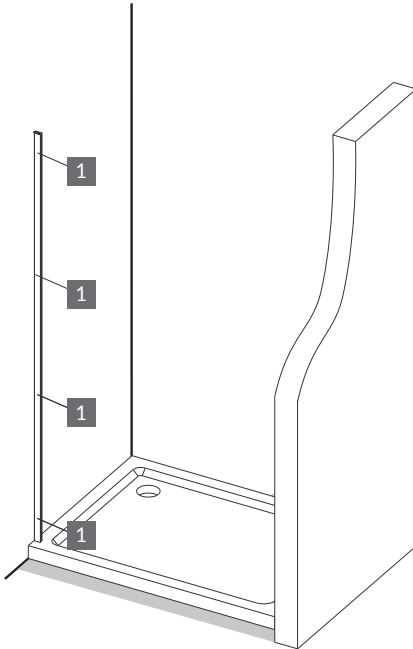
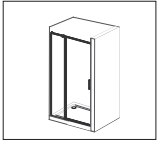

A

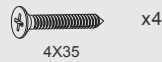

x4

P5

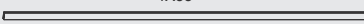

P6



6.

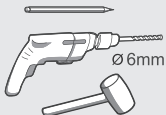
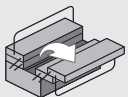
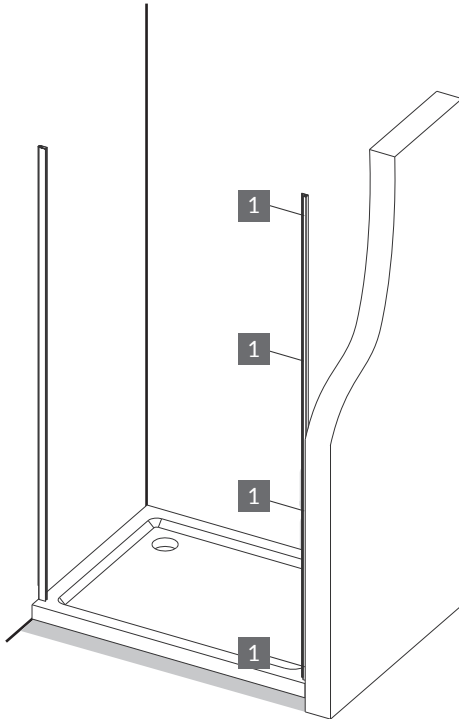
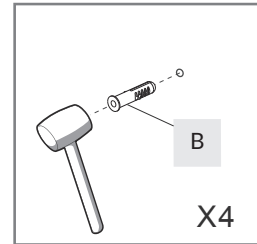
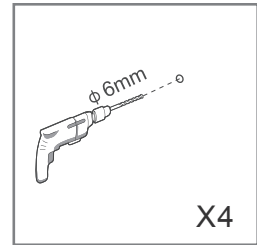
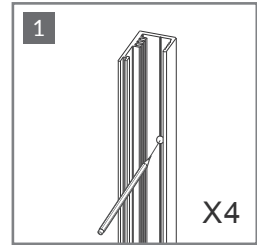
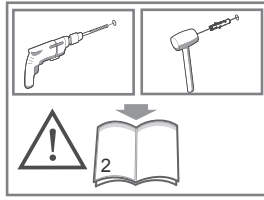
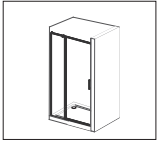

B



x4



7.

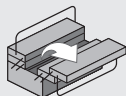
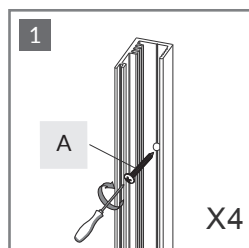
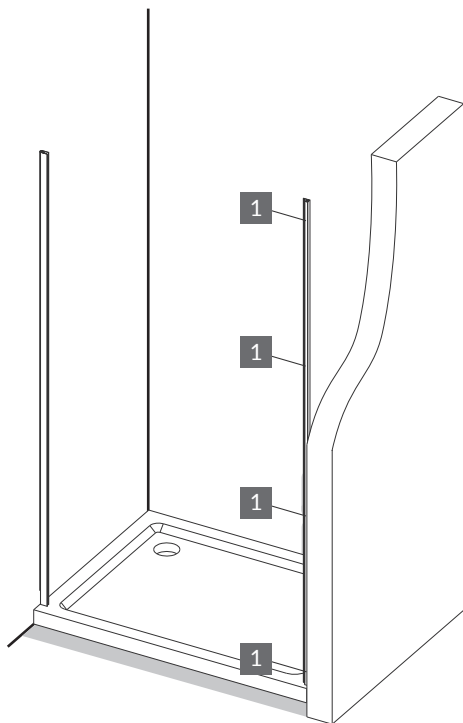

A



x4



8.

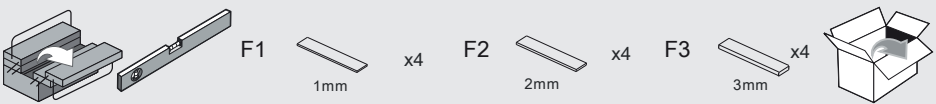
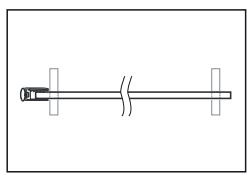
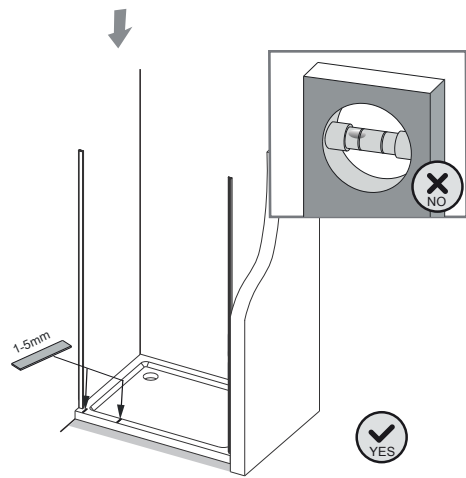
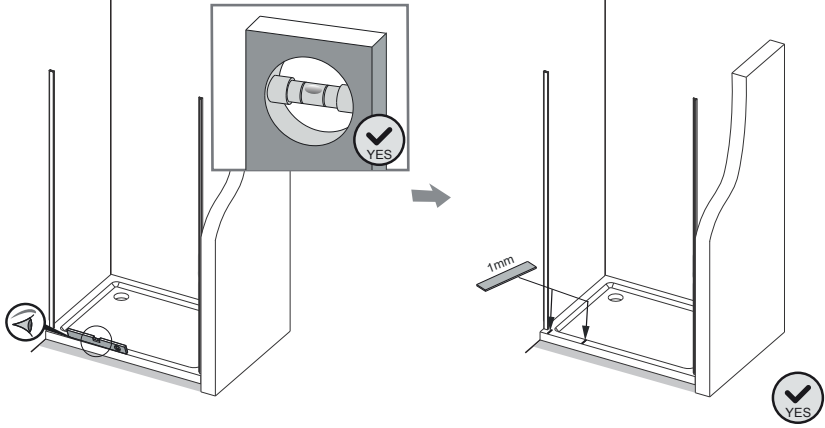
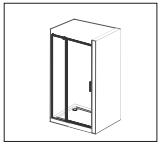

# 9.

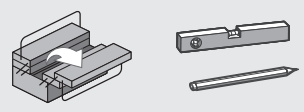
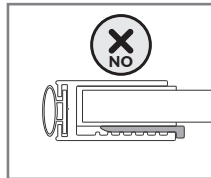
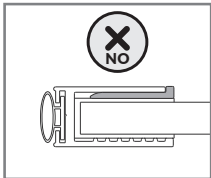
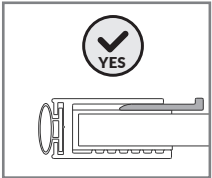
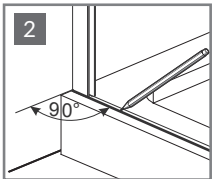
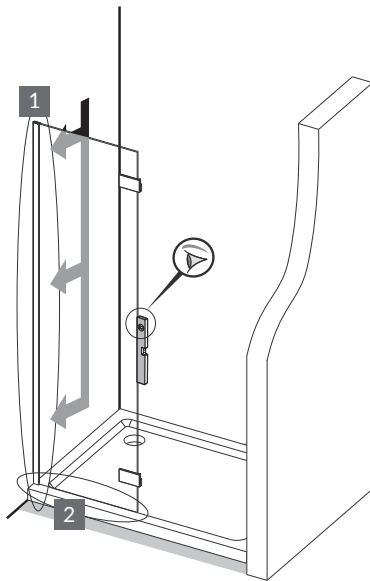
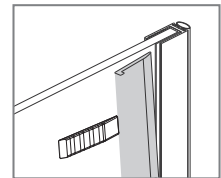
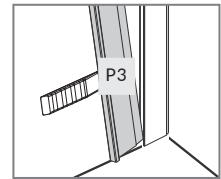
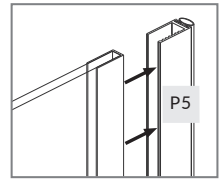
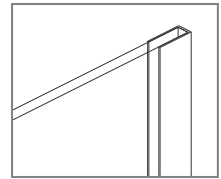
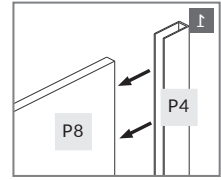
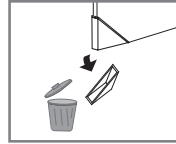
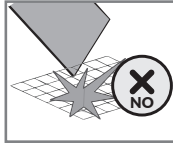
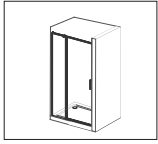

- P4 x1
- P3 x1
- M x1



# 10.

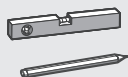
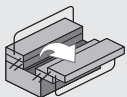
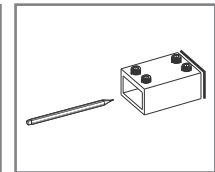
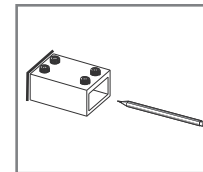
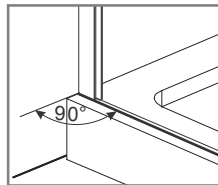
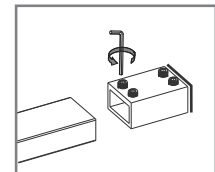
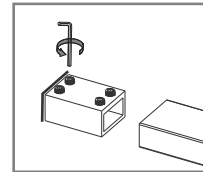
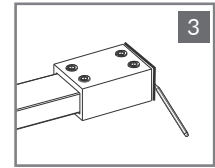
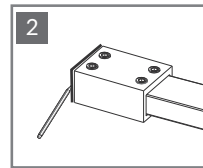
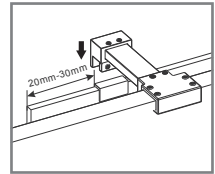
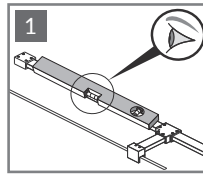
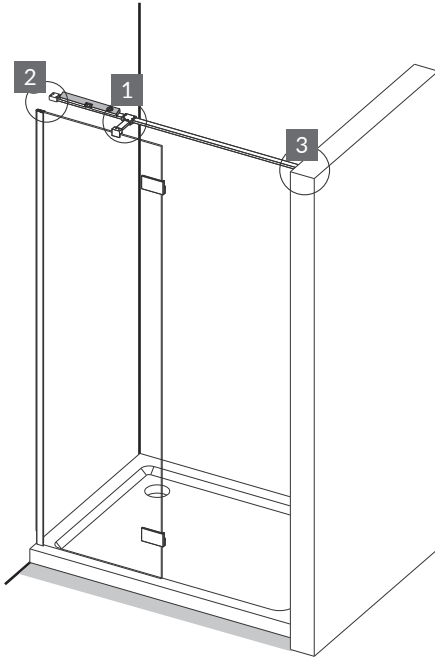
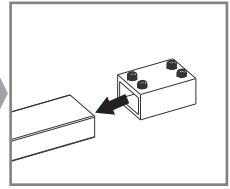
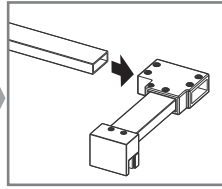
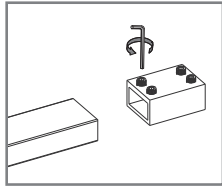
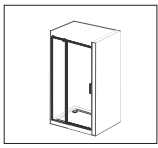

P9

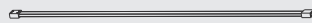

x1

P10

4X35

x4



x4

x1



# 11.

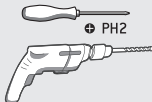
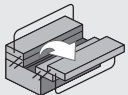
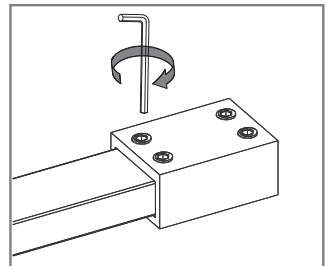
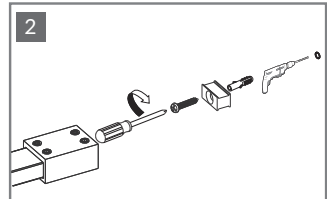
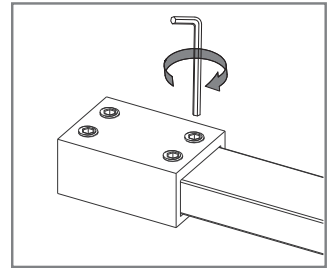
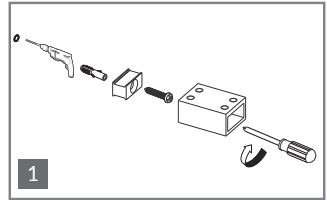
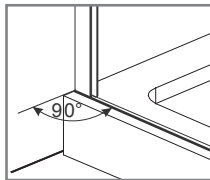
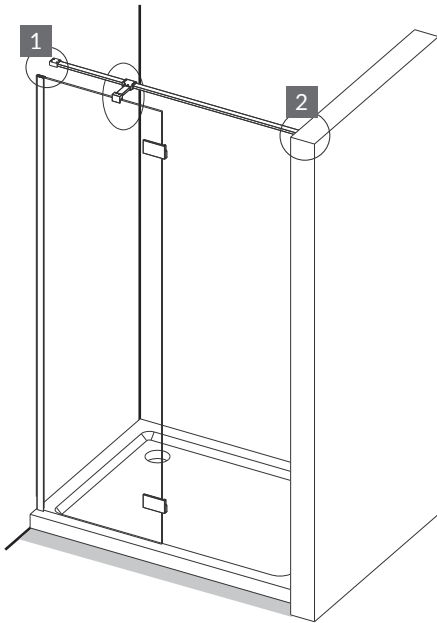
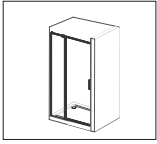

P9

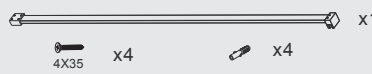

4X35 x4

x4



12.

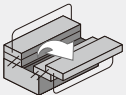
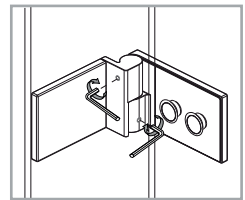
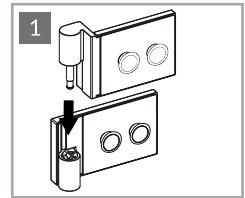
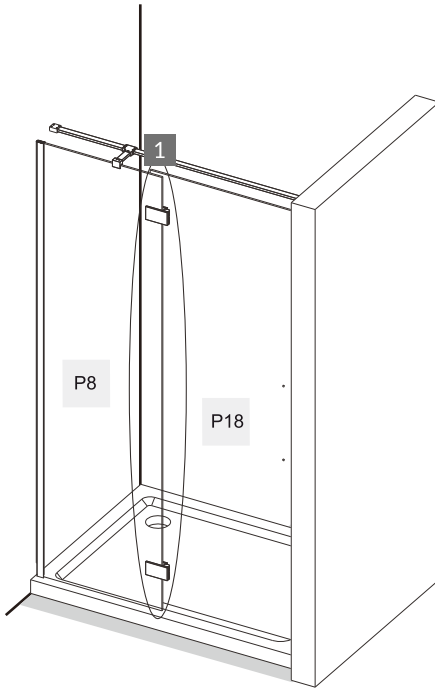

N  x1  
2mm





# 13.

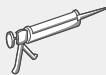
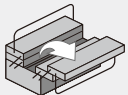
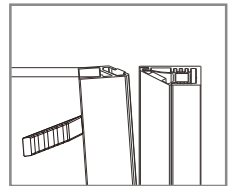
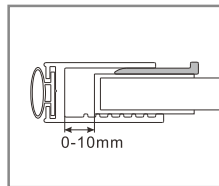
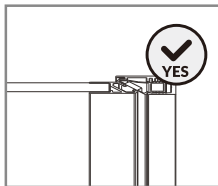
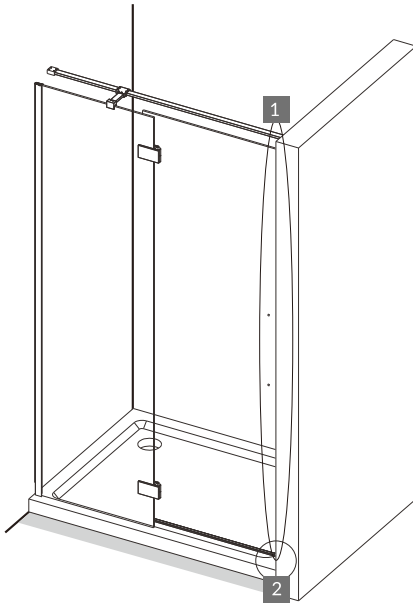
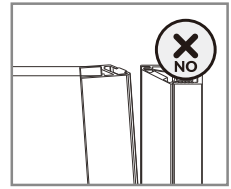
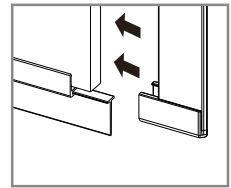
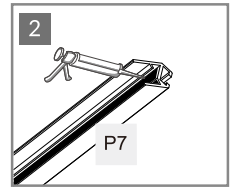
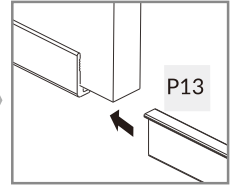
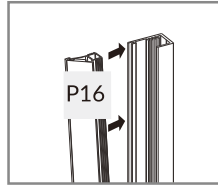
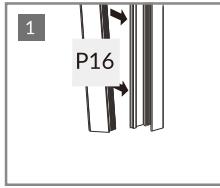
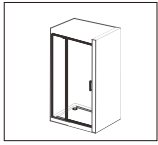

P7

P13

P16

M

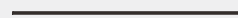

x1

x1

x1

x1



14.

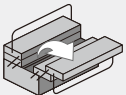
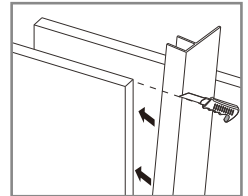
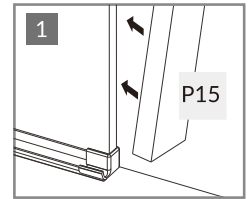
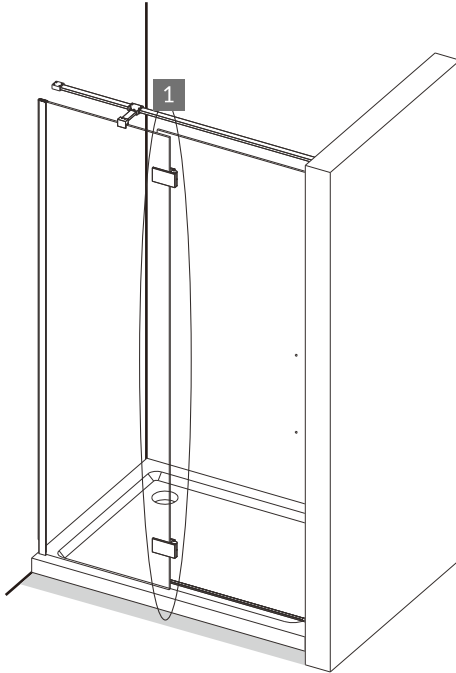
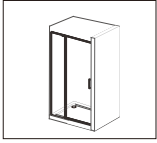

P15



x1



# 15.

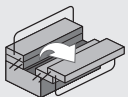
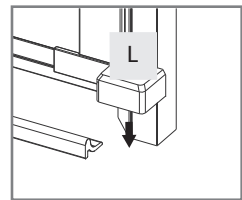
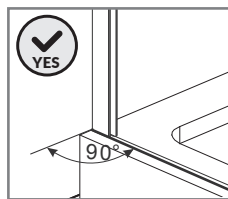
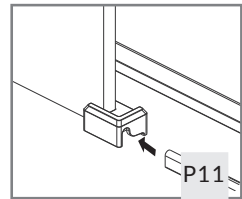
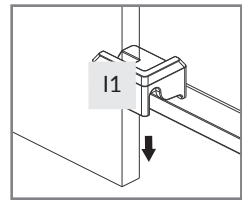
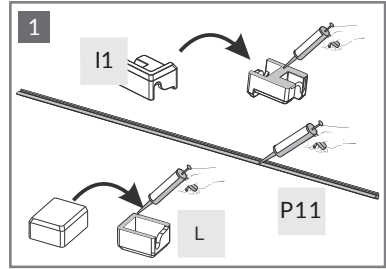
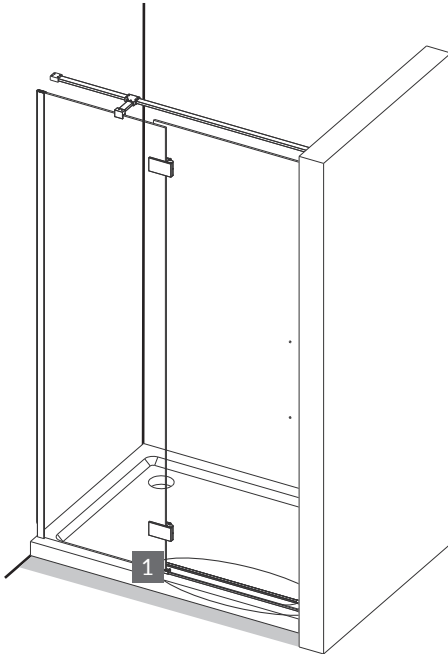
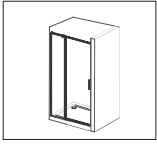

I1



x1

L



x1

P11



x1



16.

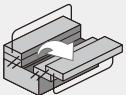
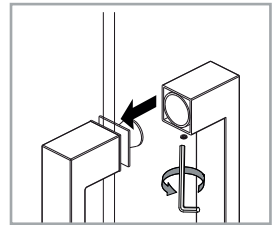
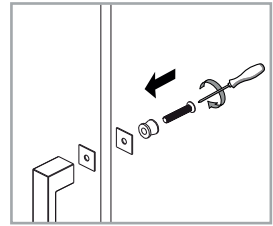
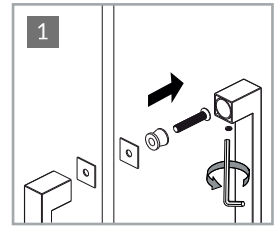
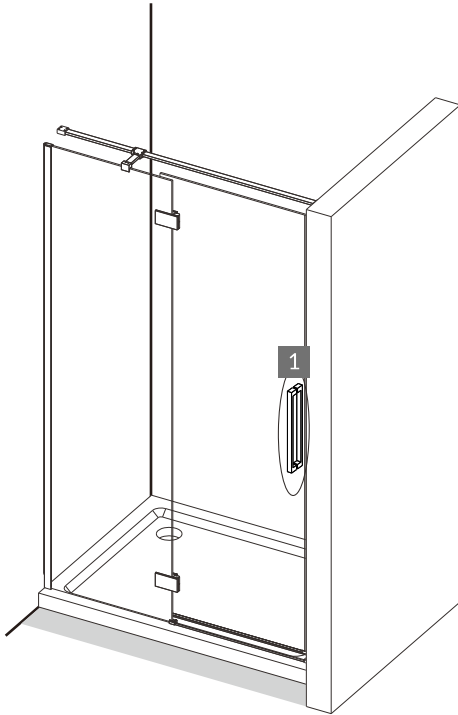
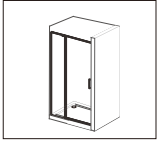

P14



x1



17.

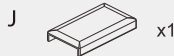
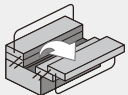
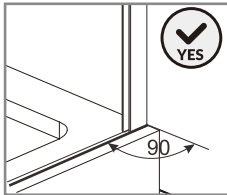
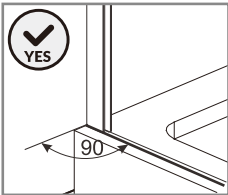
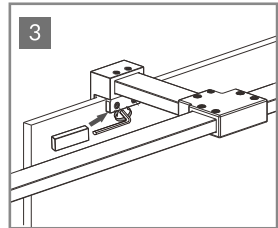
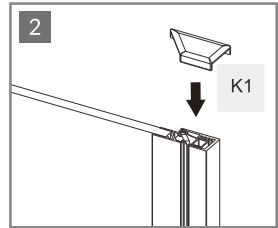
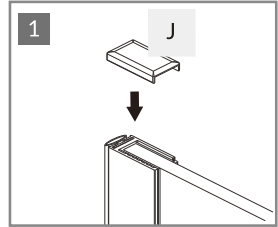
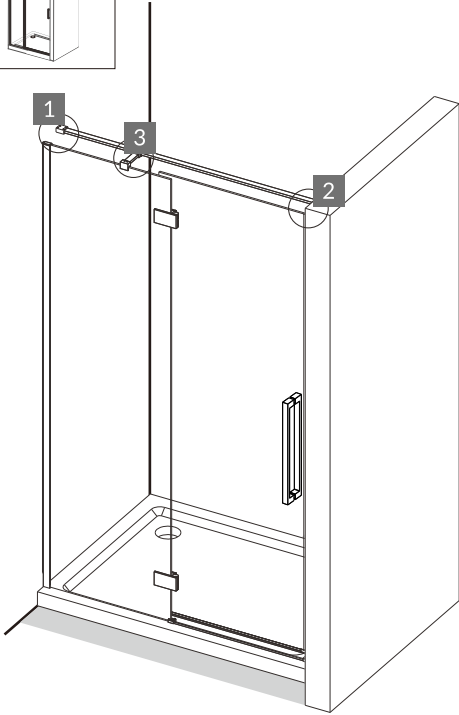
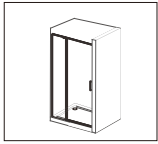

18.

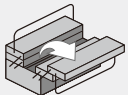
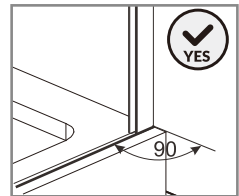
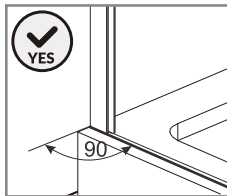
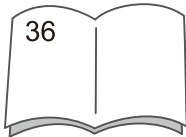
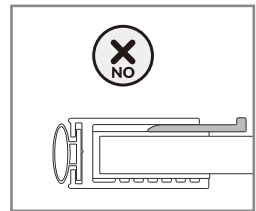
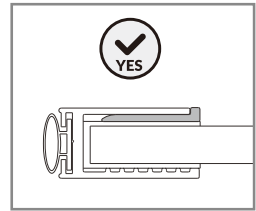
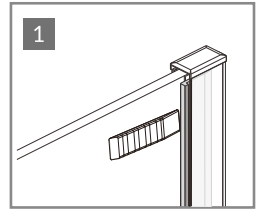
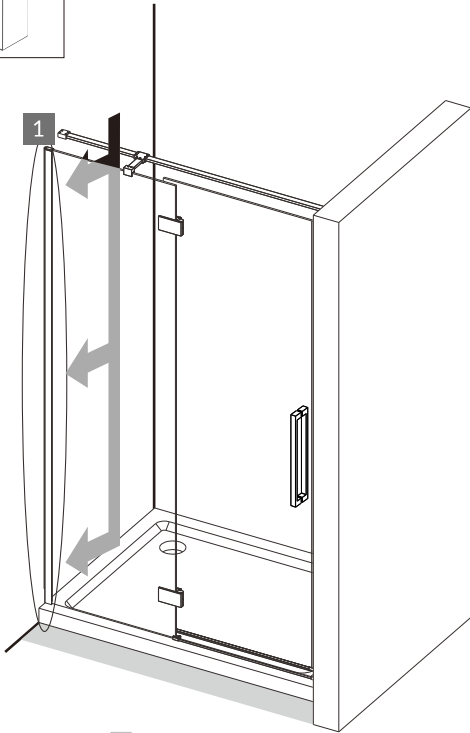
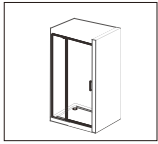

M



x1



# 19.

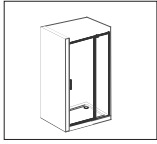

SIZE	X(mm)
900×2000	890-900
1000×2000	990-1000
1200×2000	1190-1200

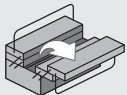
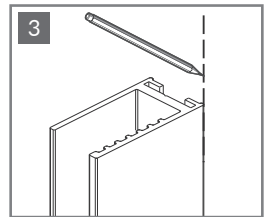
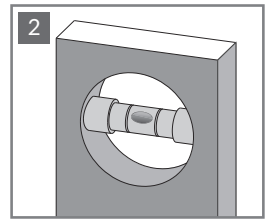
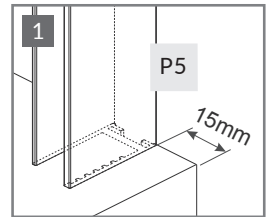
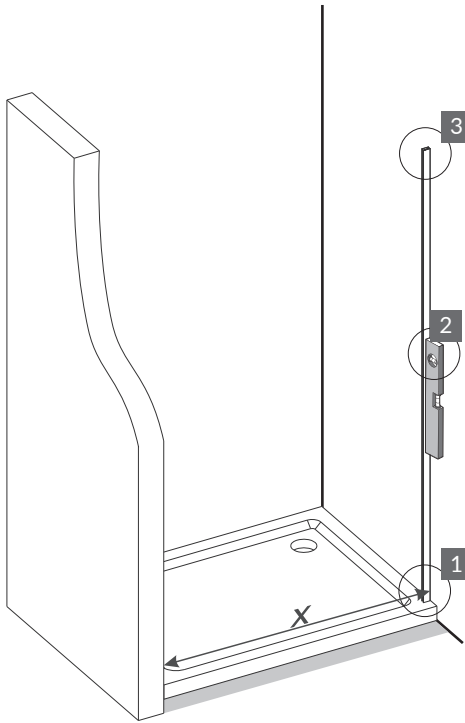

P5

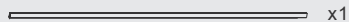

20.

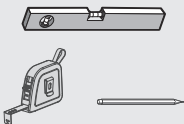
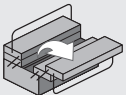
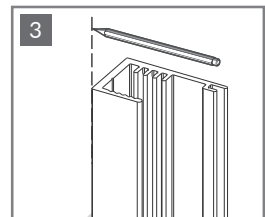
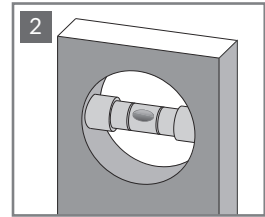
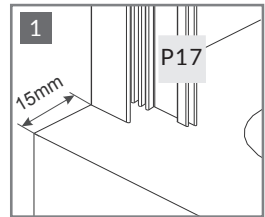
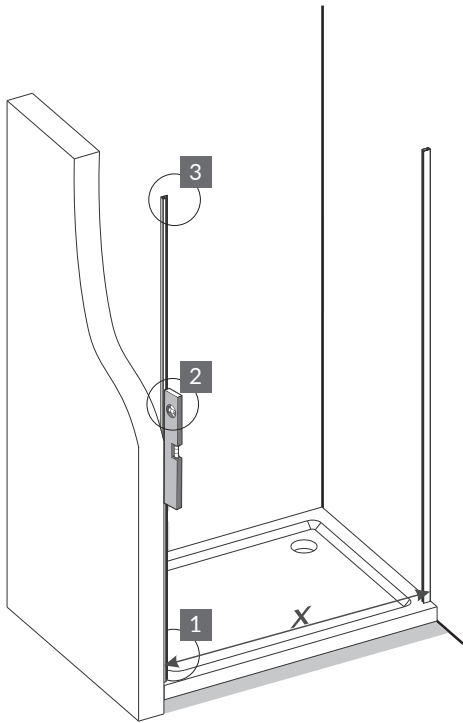
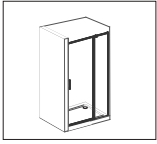

P17



x1





21.

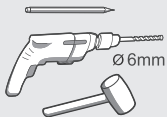
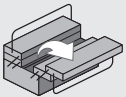
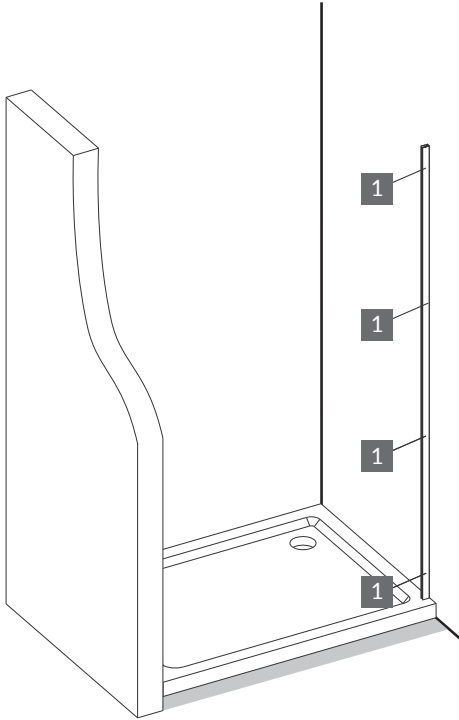
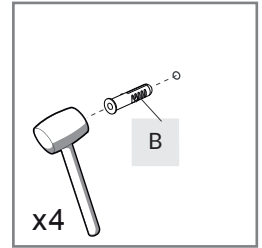
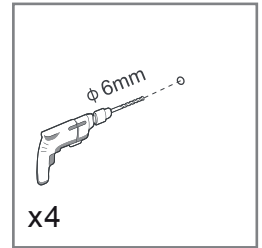
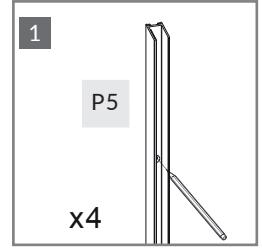
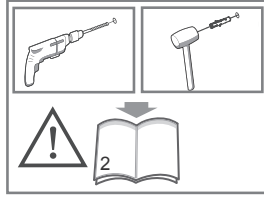
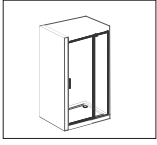

B



x4

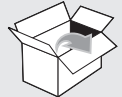

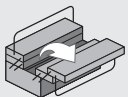
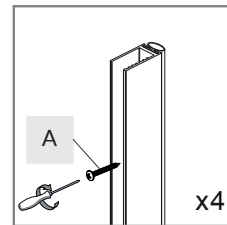
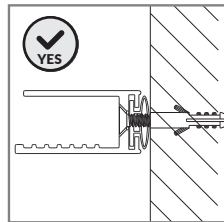
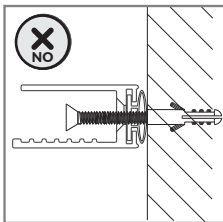
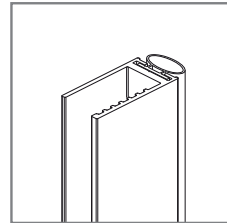
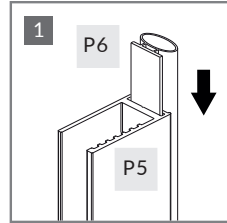
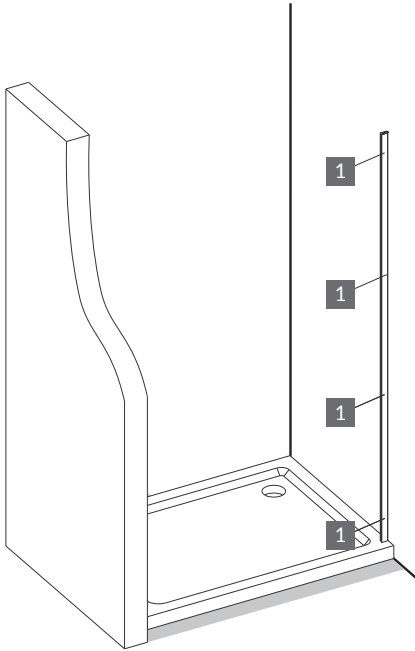
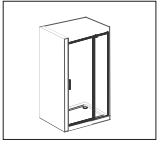

A



x4

P5

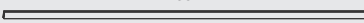

P6



23.

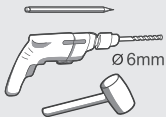
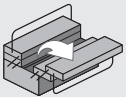
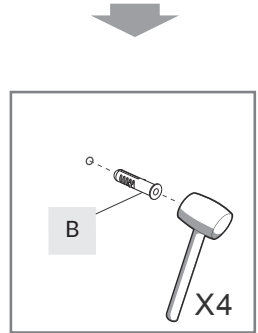
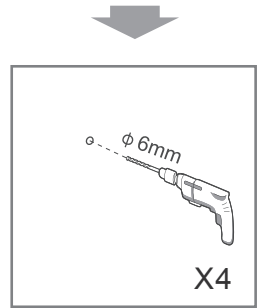
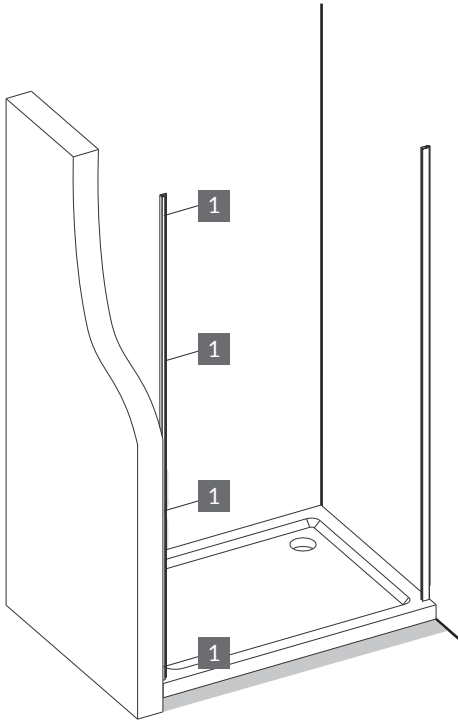
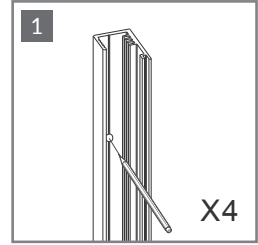
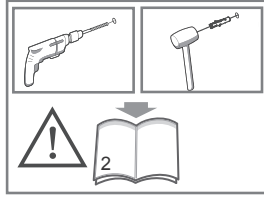
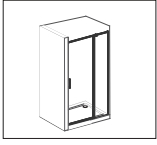

B



x4

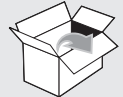

24.

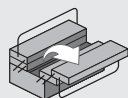
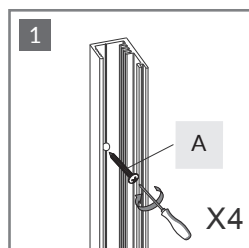
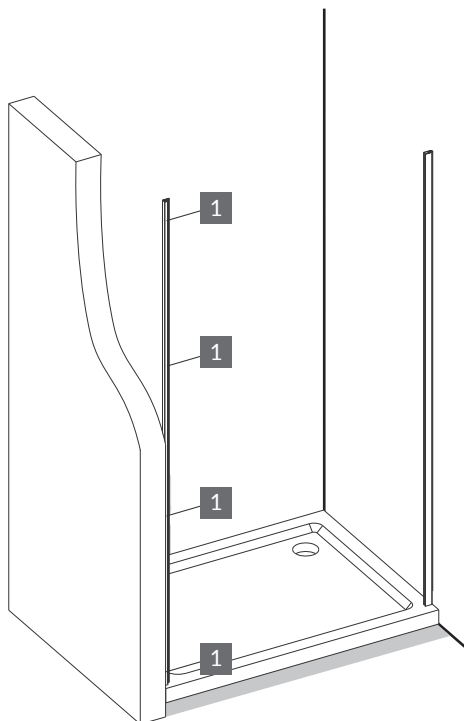

A





x4

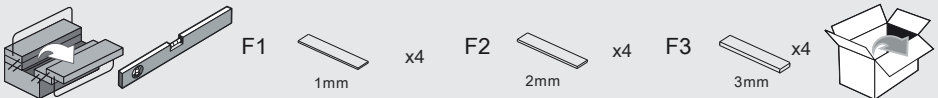
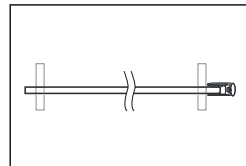
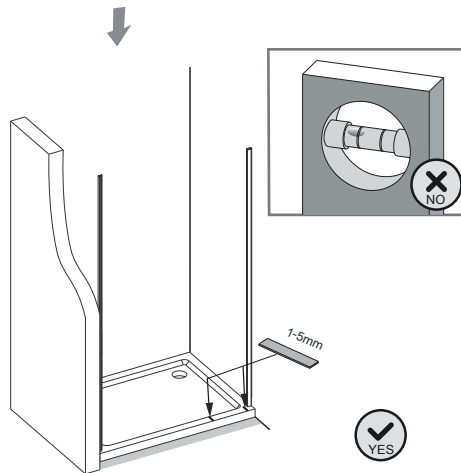
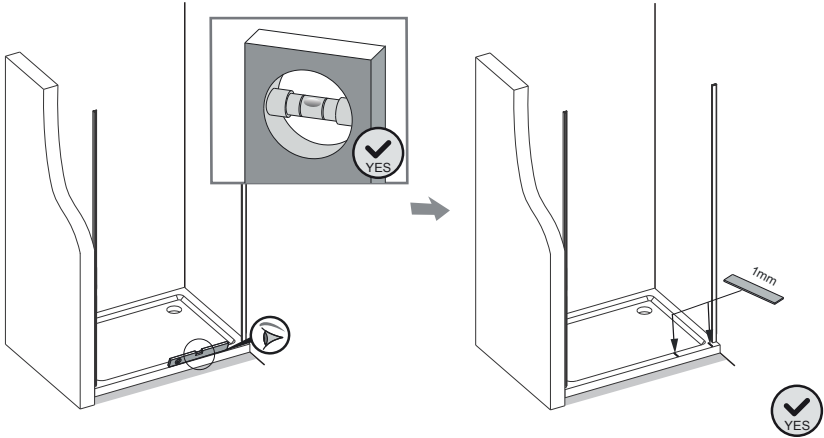
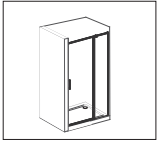

25.

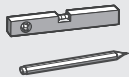
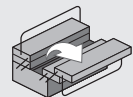
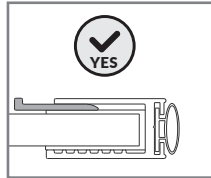
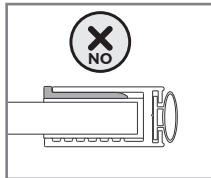
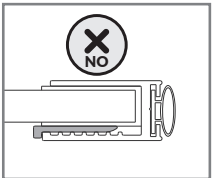
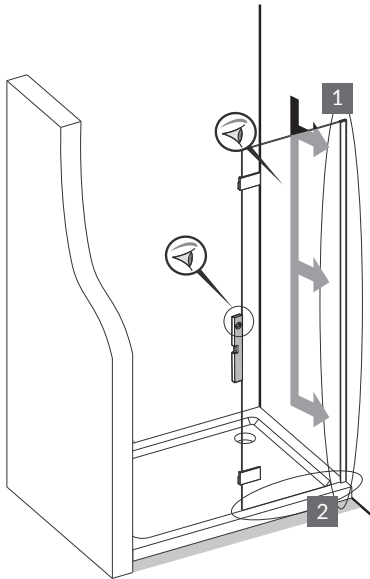
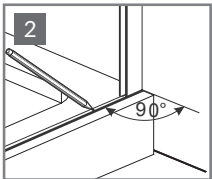
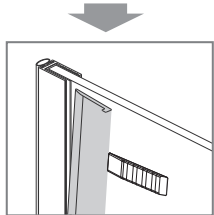
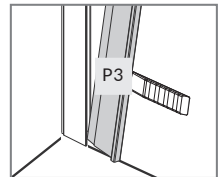
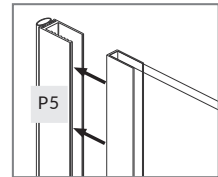
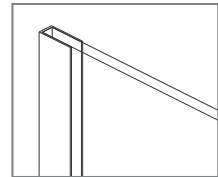
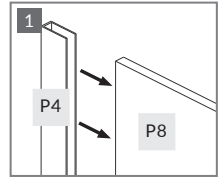
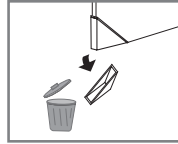
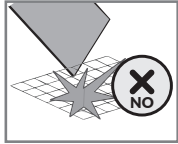
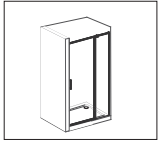

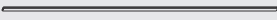

- P4  x1
- P3  x1
- M  x1



27.

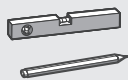
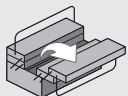
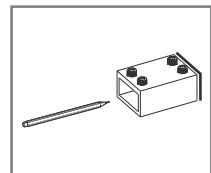
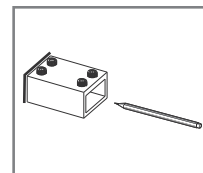
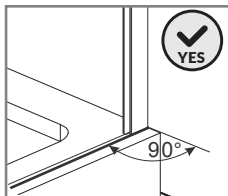
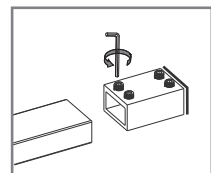
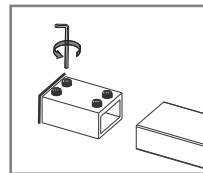
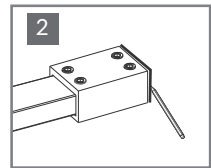
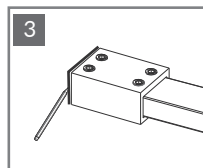
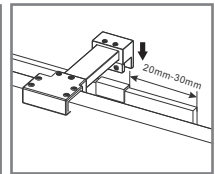
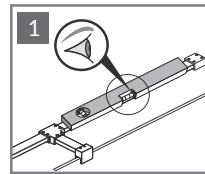
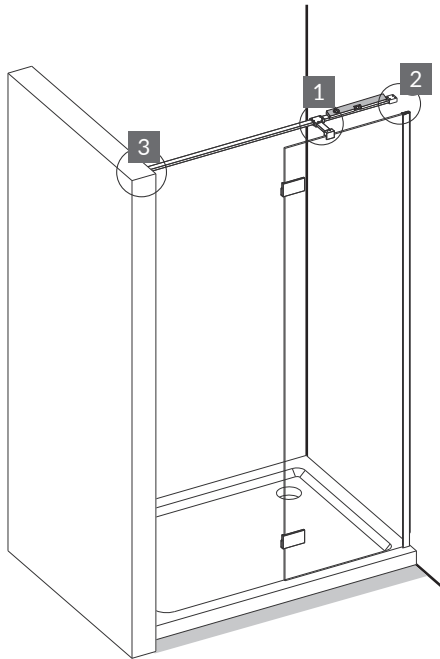
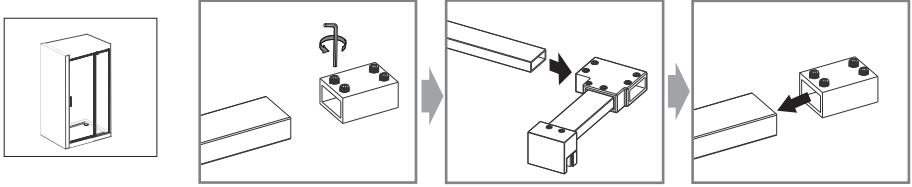

P9



x1

P10

4X35

x4



x4

x1



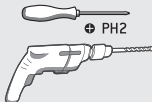
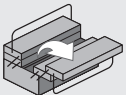
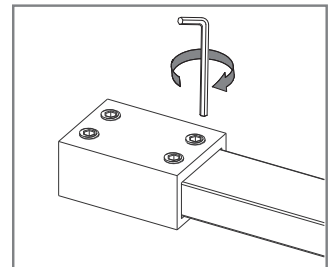
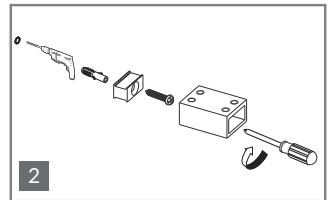
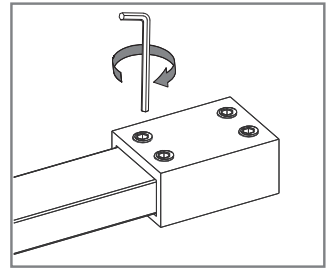
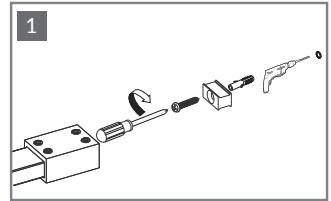
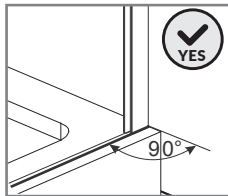
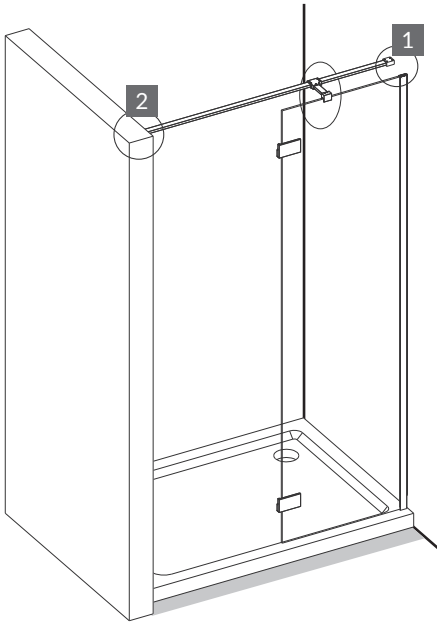
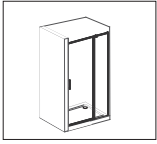

P9

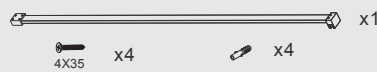

4X35 x4

x4





29.

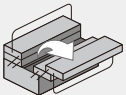
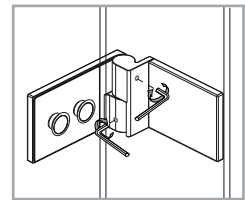
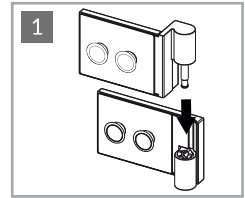
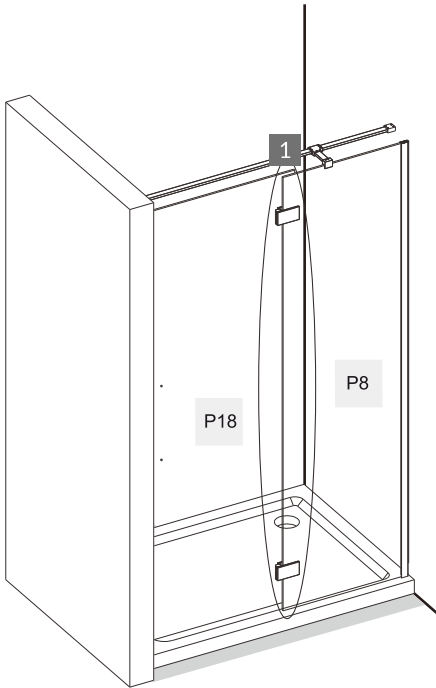
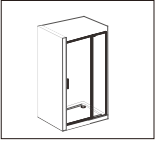

N



x1



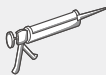
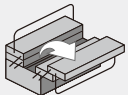
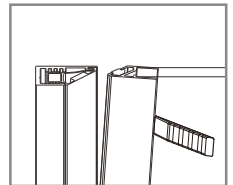
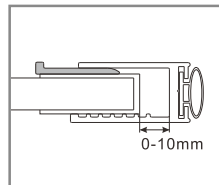
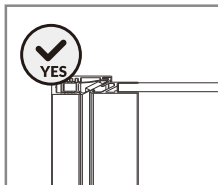
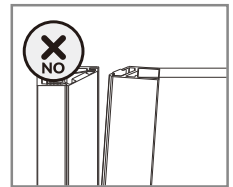
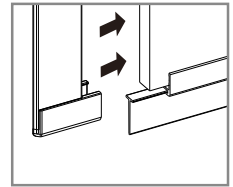
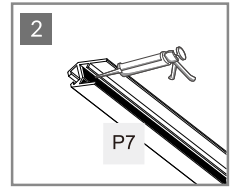
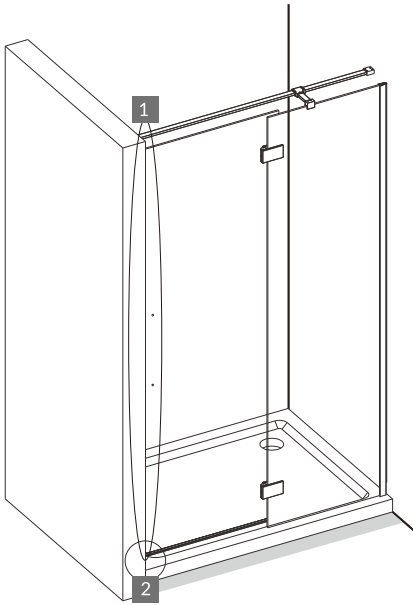
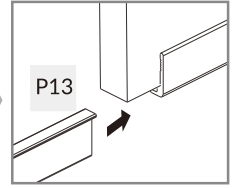
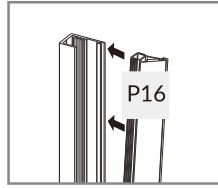
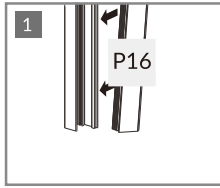
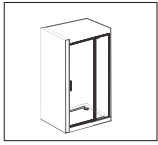

- P7 ————— x1
- P13 ————— x1
- P16 ————— x1
- M ————— x1



31.

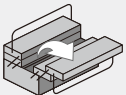
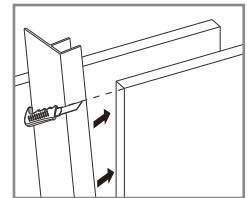
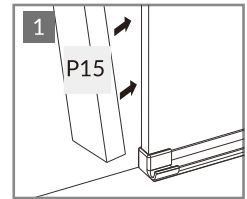
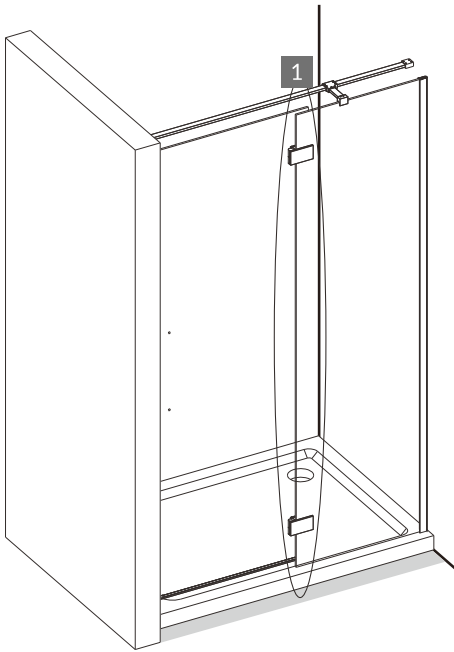
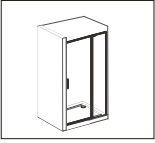

P15



x1



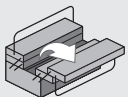
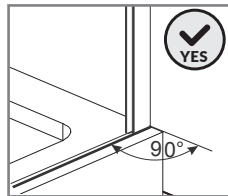
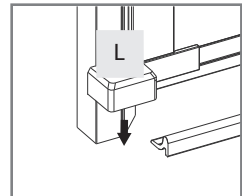
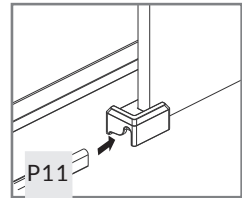
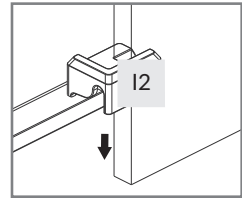
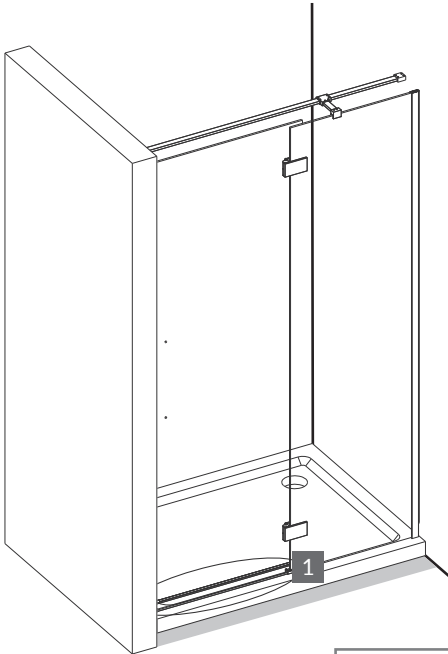
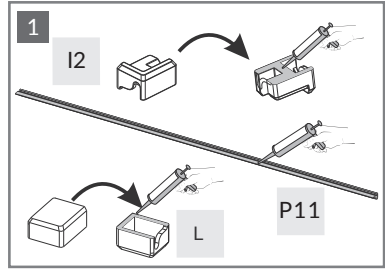
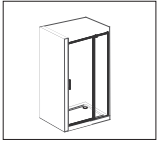

I2



x1

L



x1

P11



x1



33.

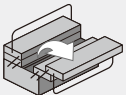
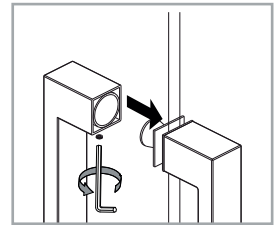
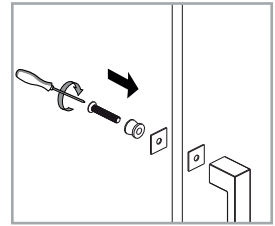
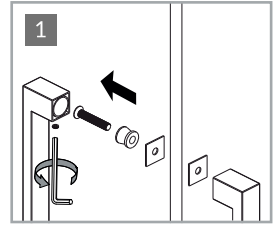
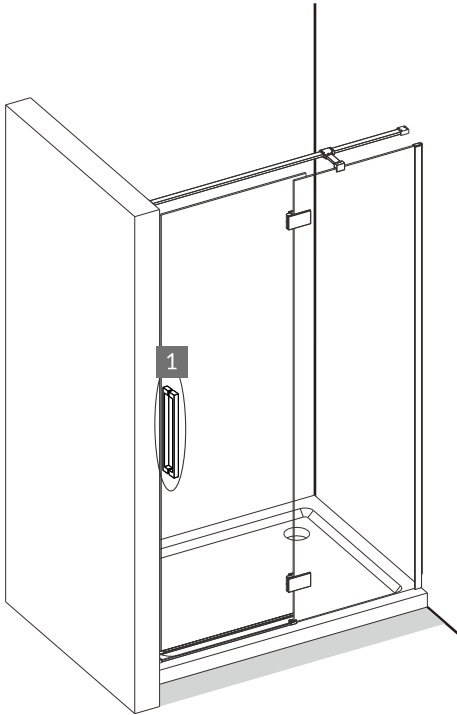
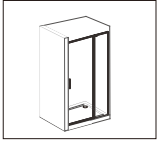

P14



x1



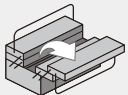
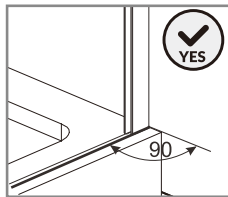
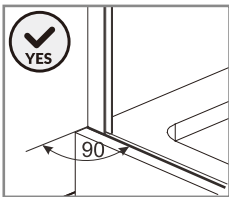
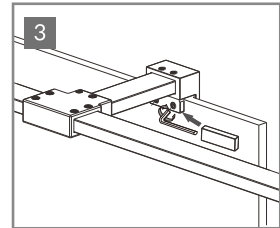
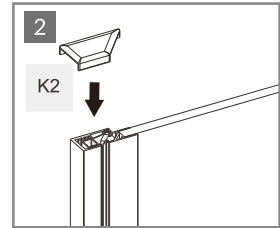
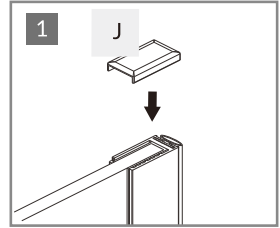
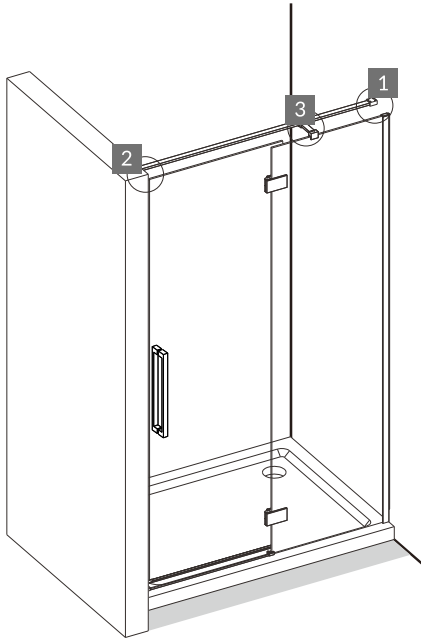
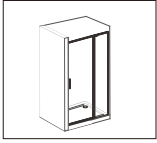

35.

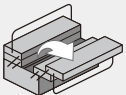
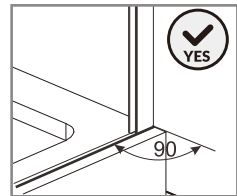
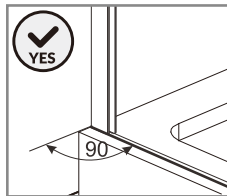
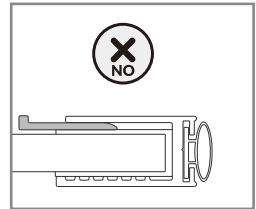
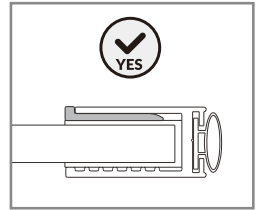
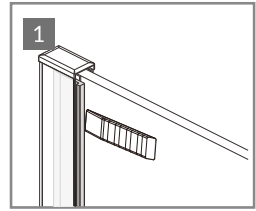
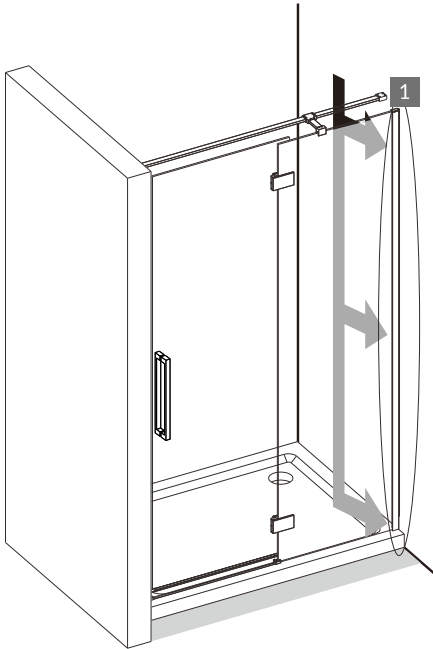
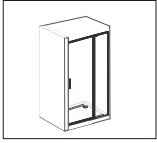

M



x1



36.

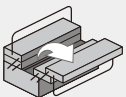
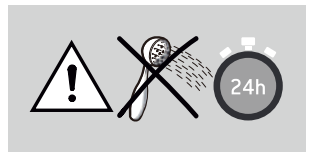
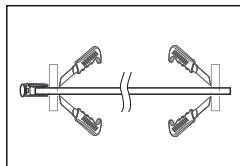
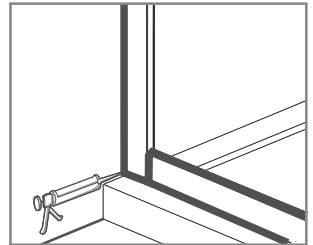
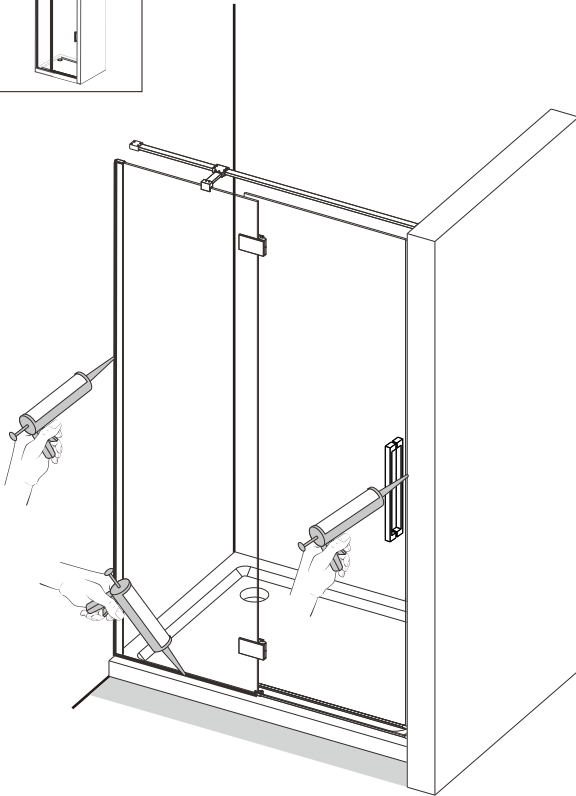
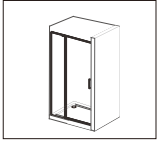





6.5 < PH < 7.5

