

PIVOT

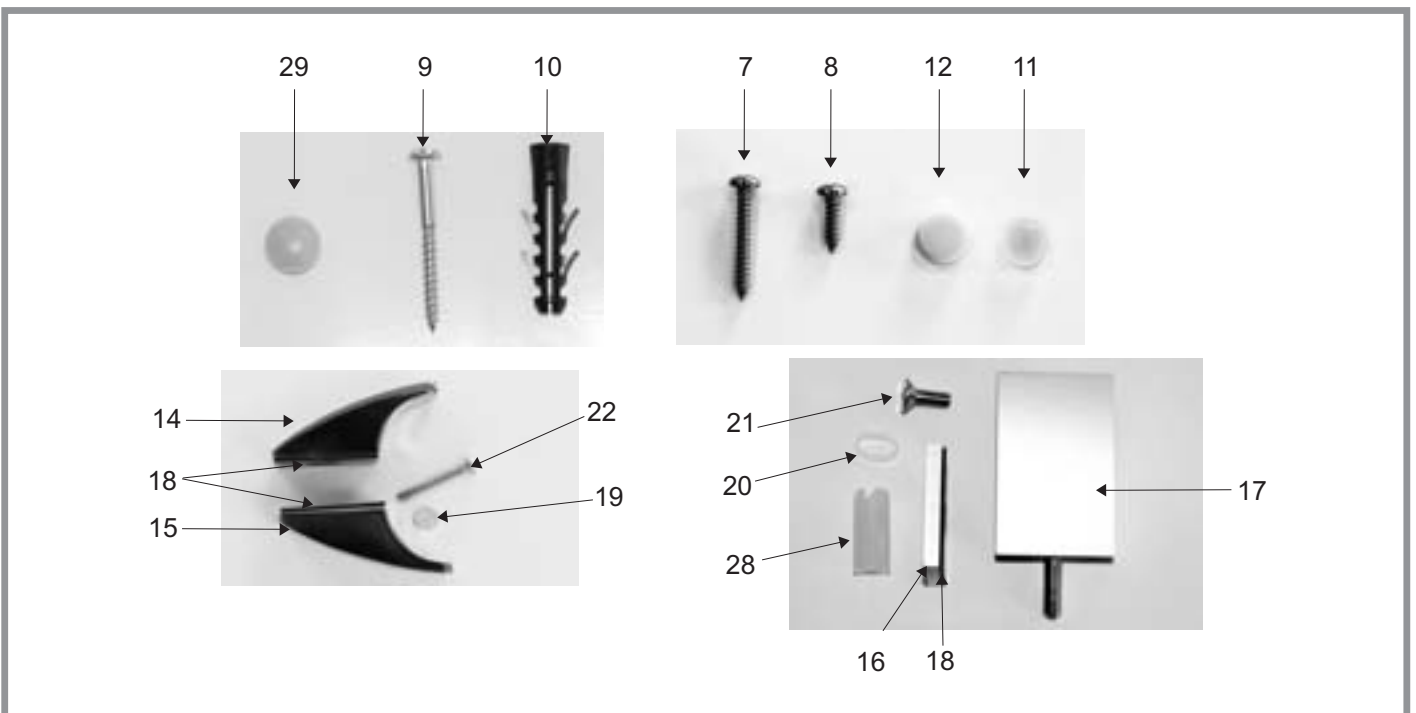

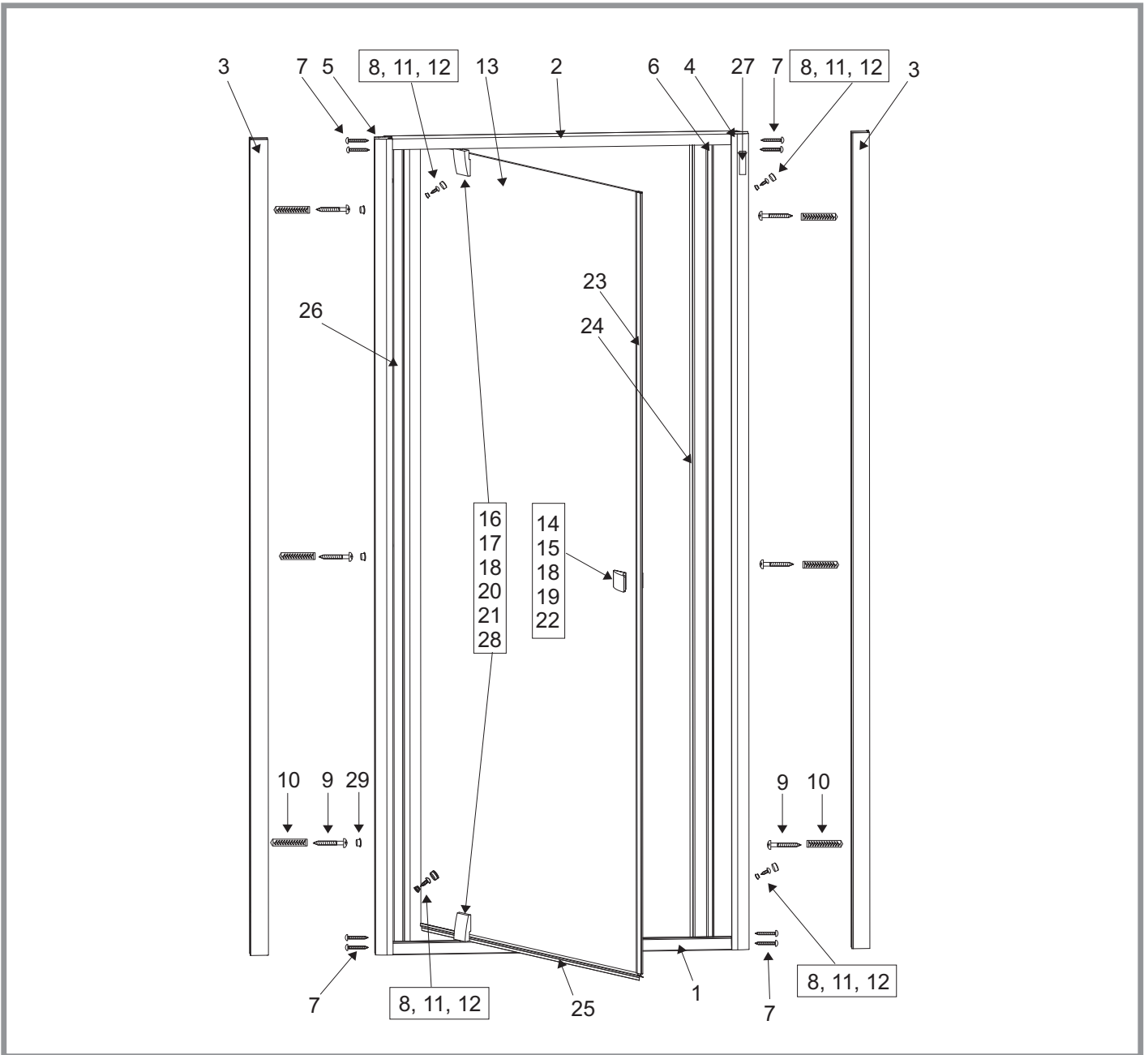









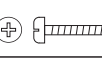
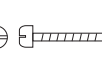
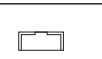
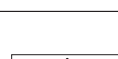

Katalog dílů

RAVAK[®]



PDOP1 - 80, PDOP1 - 90









PDOP1 - 80, PDOP1 - 90



Číslo dílu	Název dílu	Rozměr (mm)	Počet	SIČ / bílá	SIČ / elox	
1	Vodorovný profil pravý 12159/1	637	1 ks pro PDOP1 - 80	XVC1590110673	XVC15901X0673	
1	Vodorovný profil pravý 12159/2	737	1 ks pro PDOP1 - 90	XVC1590210773	XVC15902X0773	
2	Vodorovný profil levý 12159/6	637	1 ks pro PDOP1 - 80	XVC1590610673	XVC15906X0673	
2	Vodorovný profil levý 12159/7	737	1 ks pro PDOP1 - 90	XVC1590710773	XVC15907X0773	
3	Ustavovací profil 12216/1	1900	2 ks	XVC2160111900	XVC21601X1900	
4	Svislý profil 12213/2 4-otvory	1900	1 ks	XVC2130211900	XVC21302X1900	
5	Svislý profil 12213/1 7-otvorů	1900	1 ks	XVC2130111900	XVC21301X1900	
6	Svislý profil vkládací 12214/1	1877	2 ks	XVC21401X1877	XVC21401X1877	
7	Šroub samořezný DIN 7981 A2	Ø 3,5 x 25	8 ks	X97981035250	X97981035250	
8	Šroub samořezný DIN 7981 A2	Ø 3,5 x 13	4 ks	X97981035130	X97981035130	
9	Vrut do hmoždinky	Ø 4 x 40	6 ks	X94000040400	X94000040400	
10	Hmoždinka	Ø 8 pro 4 x 40	6 ks	X20600080000	X20600080000	
11	Podložka krytky 106	Ø 10 x 4,5	4 ks	X8A600000000	X8A600000000	
12	Krytka 105 (vrutu 3,5x13)	Ø 11,5 x 6	4 ks	X8A500000001	X8A500000000	
13	Sklo dveří - rovné	636 x 1824	1 ks pro PDOP1 - 80	X4Z160I246360	X4Z160I246360	
13	Sklo dveří - rovné	736 x 1824	1 ks pro PDOP1 - 90	X4Z160I247360	X4Z160I247360	
14	Madlo vnější		1 ks	Bílá X3PVV00700001 Chrom X3PVV0070000A	X3PVV0070000X	
15	Madlo vnitřní		1 ks	Bílá X3PVV00600001 Chrom X3PVV0060000A	X3PVV0060000X	
16	Příložka pantu	38 x 38 x 5	2 ks	Bílá X3PVV01500001 Chrom X3PVV0150000A	X3PVV0150000X	
17	Pant s čepem		2 ks	Bílá X3PVV01600001 Chrom X3PVV0160000A	X3PVV0160000X	
18	Pružná podložka	37 x 37	6 ks	X3PVPR0010000	X3PVPR0010000	
19	Bužírka transparent	Ø 5/7 - 5,5	1 ks	X80001075050	X80001075050	
20	Bužírka transparent	Ø 10/12 - 6	2 ks	X3G020070000	X3G020070000	
21	Šroub imbusový DIN 7991 nerez	M6 x 16	2 ks	X90991060160	X90991060160	
22	Šroub DIN 964 nerez	M4 x 30	1 ks	X90964040300	X90964040300	
23	Magnet SJ	1824	1 ks	X65622200013	X65622200013	
24	Magnet JS	1870	1 ks	X65623200014	X65623200014	
25	Okapnička	636	1 ks pro PDOP1 - 80	X65671500015	X65671500015	
25	Okapnička	736	1 ks pro PDOP1 - 90	X65671500016	X65671500016	
26	Lišta praporek	1865	1 ks	X65672500012	X65672500012	







PDOP1 - 80, PDOP1 - 90

Číslo dílu	Název dílu	Rozměr (mm)	Počet	SIČ / bílá	SIČ / elox	
27	Holografické logo RAVAK		1 ks	X21800000001	X21800000001	
28	Plastové pouzdro Pivot 134	Ø 12 x 27	2 ks	X8D400000000	X8D400000000	
29	Plastová záslepka 10/13mm	Ø 10/13	3 ks	ZZ5300ZABI	ZZ5300ZASE	

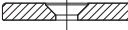
Montážní balíček PDOP1				D000001048	D00000A004	
9	Vrut do hmoždinky	Ø 4 x 40	6 ks	X94000040400	X94000040400	
10	Hmoždinka	Ø 8 pro 4 x 40	6 ks	X20600080000	X20600080000	
29	Plastová záslepka 10/13mm	Ø 10/13	3 ks	X80001100100	X80001100100	

Spojovací materiál PDOP1				D000001049	D00000O003	
7	Šroub samořezný DIN 7981 A2	Ø 3,5 x 25	8 ks	X97981035250	X97981035250	
8	Šroub samořezný DIN 7981 A2	Ø 3,5 x 13	4 ks	X97981035130	X97981035130	
11	Podložka krytky 106	Ø 10 x 4,5	4 ks	X8A600000000	X8A600000000	
12	Krytka 105 (vrutu 3,5x13)	Ø 11,5 x 6	4 ks	X8A500000001	X8A500000000	

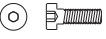
Montážní set madla				Bílá D000001001 Chrom D00000A002	D00000X001	
14	Madlo vnější		1 ks	Bílá X3PVV00700001 Chrom X3PVV0070000A	X3PVV0070000X	
15	Madlo vnitřní		1 ks	Bílá X3PVV00600001 Chrom X3PVV0060000A	X3PVV0060000X	
18	Pružná podložka	37 x 37	2 ks	X3PVPR0010000	X3PVPR0010000	
19	Bužírka transparent	Ø 5/7, 5-5	1 ks	X80001075050	X80001075050	
22	Šroub DIN 964 nerez	M4 x 30	1 ks	X90964040300	X90964040300	

Montážní set pantu				Bílá D000001052 Chrom D00000A003	D00000X002	
16	Příložka pantu	38 x 38 x 5	2 ks	Bílá X3PVV01500001 Chrom X3PVV0150000A	X3PVV0150000A	
17	Pant s čepem		2 ks	Bílá X3PVV01600001 Chrom X3PVV0160000A	X3PVV0160000X	
18	Pružná podložka	37 x 37	4 ks	X3PVPR0010000	X3PVPR0010000	
20	Bužírka transparent	Ø 10/12-6	2 ks	X3G20070000	X3G020070000	
21	Šroub DIN 7991 nerez	M6 x 16	2 ks	X90991060160	X90991060160	
28	Plastové pouzdro Pivot 134	Ø 12 x 27	2 ks	X8D000000000	X8D000000000	



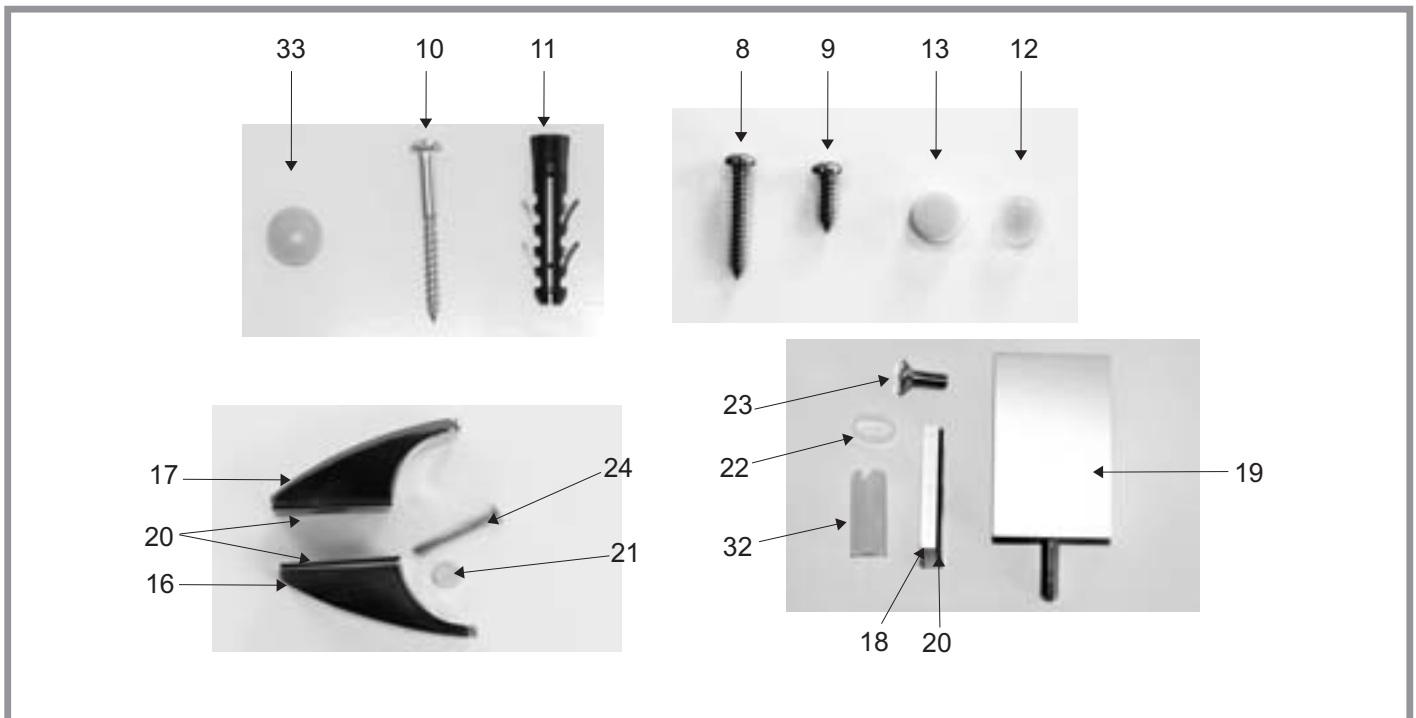
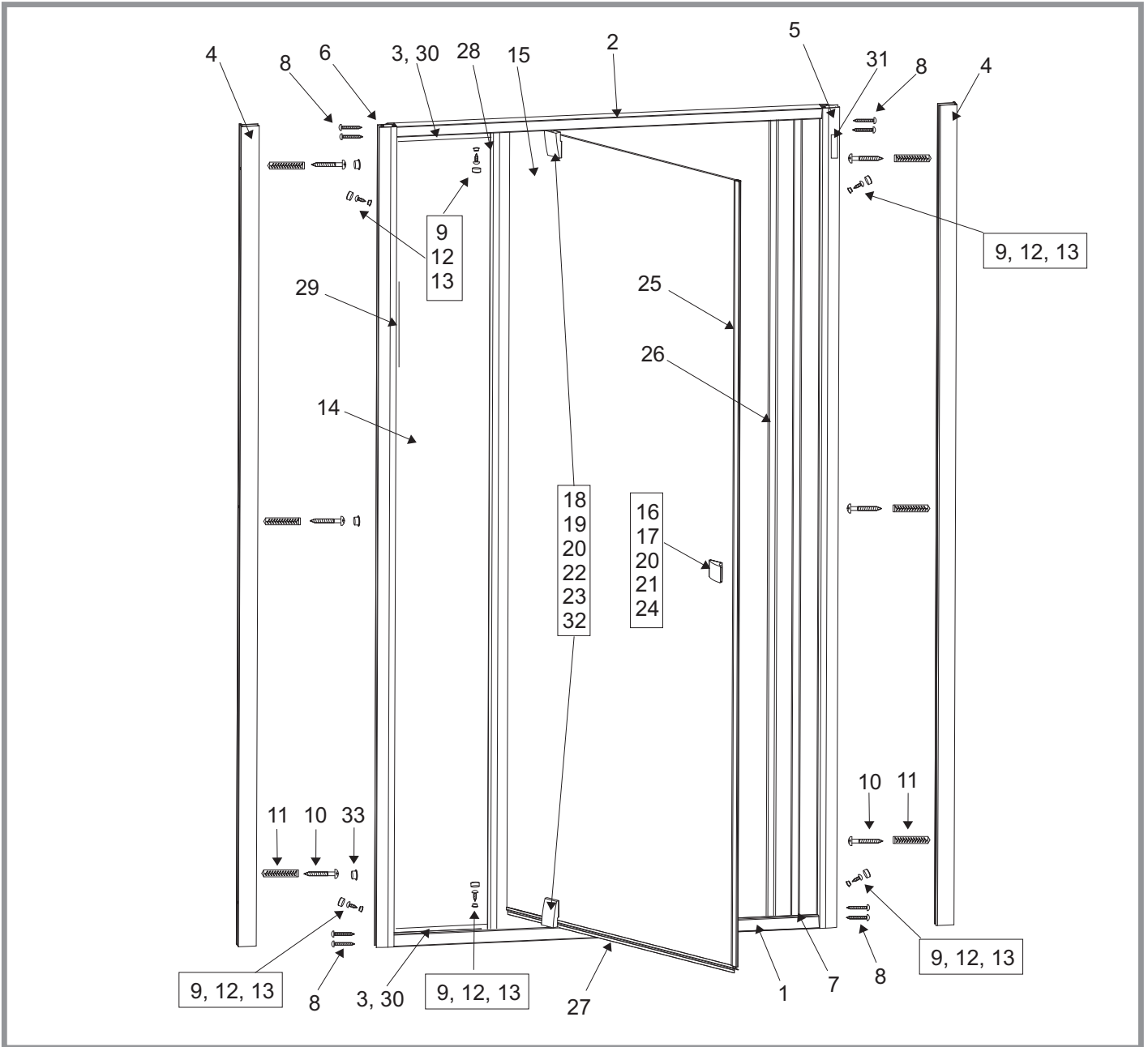







PDOP2 - 100, PDOP2 - 110, PDOP2 - 120









PDOP2 - 100, PDOP2 - 110, PDOP2 - 120



Číslo dílu	Název dílu	Rozměr (mm)	Počet	SIČ / bílá	SIČ / elox	
1	Vodorovný profil pravý 12159/3	837	1 ks pro PDOP2 - 100	XVC1590310873	XVC15903X0873	
1	Vodorovný profil pravý 12159/4	937	1 ks pro PDOP2 - 110	XVC1590410973	XVC15904X0973	
1	Vodorovný profil pravý 12159/5	1037	1 ks pro PDOP2 - 120	XVC1590511073	XVC15905X1073	
2	Vodorovný profil levý 12159/8	837	1 ks pro PDOP2 - 100	XVC1590810873	XVC15908X0873	
2	Vodorovný profil levý 12159/9	937	1 ks pro PDOP2 - 110	XVC1590910973	XVC15909X0973	
2	Vodorovný profil levý 12159/10	1037	1 ks pro PDOP2 - 120	XVC1591011073	XVC15910X1073	
3	Zasklívací Profil RA-AL-009/51	220	2 ks pro PDOP2 - 100/110	XVRA095110220	XVRA0951X0220	
3	Zasklívací Profil RA-AL-009/52	320	2 ks pro PDOP2 - 120	XVRA095210320	XVRA0952X0320	
4	Ustavovací profil 12216/1	1900	2 ks	XVC2160111900	XVC21601X1900	
5	Svislý profil 12213/2 4-otvory	1900	1 ks	XVC2130211900	XVC21302X1900	
6	Svislý profil 12213/2 7-otvorů	1900	1 ks	XVC2130111900	XVC21301X1900	
7	Svislý profil vkládací 12214 /1	1877	1 ks	XVC21401X1877	XVC21401X1877	
8	Šroub samořezný DIN 7981 A2	Ø 3,5 x 25	8 ks	X97981035250	X97981035250	
9	Šroub samořezný DIN 7981 A2	Ø 3,5 x 13	6 ks	X97981035130	X97981035130	
10	Vrut do hmoždinky	Ø 4 x 40	6 ks	X94000040400	X94000040400	
11	Hmoždinka	Ø 8 pro 4 x 40	6 ks	X20600080000	X20600080000	
12	Podložka krytky 106	Ø 10 x 4,5	6 ks	X8A600000000	X8A600000000	
13	Krytka 105 (vrutu 3,5x13)	Ø 11,5 x 6	6 ks	X8A500000001	X8A500000000	
14	Sklo PS rovné (bez děr)	216 x 1870	1 ks pro PDOP2 - 100/110	X4Z1601702160	X4Z1601702160	
14	Sklo PS rovné (bez děr)	316 x 1870	1 ks pro PDOP2 - 120	X4Z1601703160	X4Z1601703160	
15	Sklo dveří - rovné	636 x 1824	1 ks pro PDOP2 - 100	X4Z1601246360	X4Z1601246360	
15	Sklo dveří - rovné	736 x 1824	1 ks pro PDOP2 - 110/120	X4Z1601247360	X4Z1601247360	
16	Madlo vnější		1 ks	Bílá X3PVV00700001 Chrom X3PVV0070000A	X3PVV0070000X	
17	Madlo vnitřní		1 ks	Bílá X3PVV00600001 Chrom X3PVV0060000A	X3PVV0060000X	
18	Příložka pantu	38 x 38 x 5	2 ks	Bílá X3PVV01500001 Chrom X3PVV0150000A	X3PVV0150000X	
19	Pant s čepem		2 ks	Bílá X3PVV01600001 Chrom X3PVV0160000A	X3PVV0160000X	
20	Pružná podložka	37 x 37	6 ks	X3PVPR0010000	X3PVPR0010000	
21	Bužírka transparent	Ø 5/7 x 5,5	1 ks	X80001075050	X80001075050	
22	Bužírka transparent	Ø 10/12 - 6	2 ks	X3G020070000	X3G020070000	







PDOP2 - 100, PDOP2 - 110, PDOP2 - 120

Číslo dílu	Název dílu	Rozměr (mm)	Počet	SIČ / bílá	SIČ / elox	
23	Šroub imbusový DIN 7991 nerez	M6x16	2 ks	X90991060160	X90991060160	
24	Šroub DIN 964 nerez	M4x30	1 ks	X90964040300	X90964040300	
25	Magnet SJ	1824	1 ks	X65622200013	X65622200013	
26	Magnet JS	1870	2 ks	X65623200014	X65623200014	
27	Okapnička	636	1 ks pro PDOP2 - 100	X65671500015	X65671500015	
27	Okapnička	736	1 ks pro PDOP2 - 110/120	X65671500016	X65671500016	
28	Lišta praporek	1865	1 ks	X65671500016	X65672500012	
29	Zasklívací profil číslo 90 - svislý	1870	1 ks	X89000000000	X89000000000	
30	Zasklívací profil č. 111 - vodorovný	200	2 ks pro PDOP2 - 100/110	X8B100000000	X8B100000000	
30	Zasklívací profil č. 111 - vodorovný	300	2 ks pro PDOP2 - 120	X8B100000000	X8B100000000	
31	Holografické logo RAVAK		1 ks	X21800000001	X21800000001	
32	Plastové pouzdo Pivot 134	Ø 12 x 27	2 ks	X8D400000000	X8D400000000	
33	Plastová záslepka 10/13mm	Ø 10/13	3 ks	ZZ5300ZABI	ZZ5300ZASE	

Montážní balíček PDOP2				D000001048	D00000A004	
10	Vrut do hmoždinky	Ø 4 x 40	6 ks	X94000040400	X94000040400	
11	Hmoždinka	Ø 8 pro 4 x 40	6 ks	X20600080000	X20600080000	
33	Plastová záslepka	Ø 10/13	3 ks	X80001100100	X80001100100	

Spojovací materiál PDOP2				D000001050	D00000O004	
8	Šroub samořezný DIN 7981 A2	Ø 3,5 x 25	8 ks	X97981035250	X97981035250	
9	Šroub samořezný DIN 7981 A2	Ø 3,5 x 13	6 ks	X97981035130	X97981035130	
12	Podložka krytky 106	Ø 10 x 4,5	6 ks	X8A600000000	X8A600000000	
13	Krytka 105 (vrutu 3,5x13)	Ø 11,5 x 6	6 ks	X8A500000001	X8A500000000	



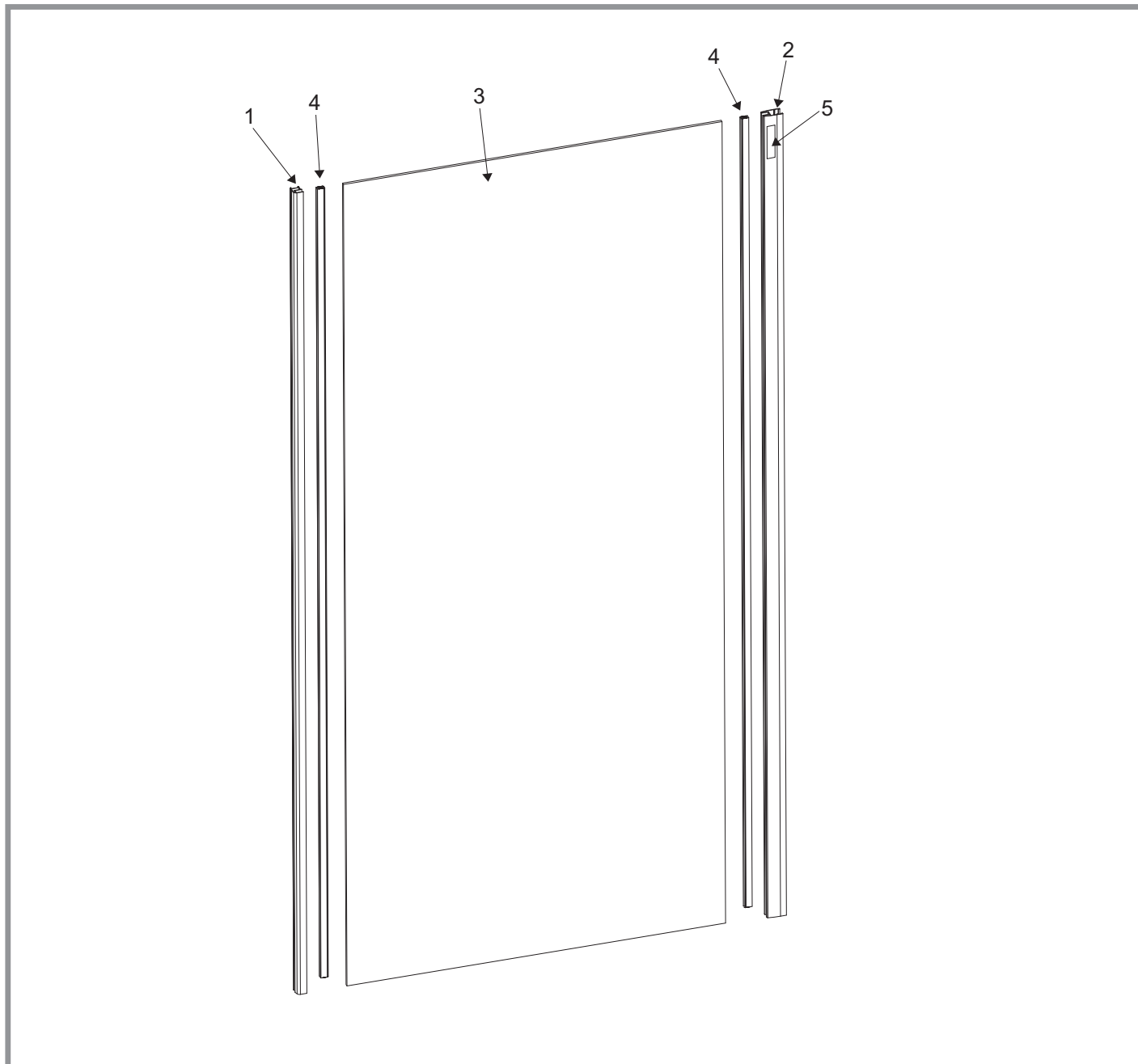

Číslo dílu	Název dílu	Rozměr (mm)	Počet	SIČ / bílá	SIČ / elox	
Montážní set madla				Bílá D000001001 Chrom D00000A002	D00000X001	
16	Madlo vnější		1 ks	Bílá X3PVV00700001 Chrom X3PVV0070000A	X3PVV0070000X	
17	Madlo vnitřní		1 ks	Bílá X3PVV00600001 Chrom X3PVV0060000A	X3PVV0060000X	
20	Pružná podložka	37 x 37	2 ks	X3PVPR0010000	X3PVPR0010000	
21	Bužírka transparent	Ø 5/7, 5-5	1 ks	X80001075050	X80001075050	
24	Šroub DIN 964 nerez	M4 x 30	1 ks	X90964040300	X90964040300	

Číslo dílu	Název dílu	Rozměr (mm)	Počet	SIČ / bílá	SIČ / elox	
Montážní set pantu				Bílá D000001052 Chrom D00000A003	D00000X002	
18	Pant s čepem		2 ks	Bílá X3PVV01600001 Chrom X3PVV0160000A	X3PVV0160000X	
19	Příložka pantu	38 x 38 x 5	2 ks	Bílá X3PVV01500001 Chrom X3PVV0150000A	X3PVV0150000A	
20	Pružná podložka	37 x 37	4 ks	X3PVPR0010000	X3PVPR0010000	
22	Bužírka transparent	Ø 10/12-6	2 ks	X3G20070000	X3G020070000	
23	Šroub DIN 7991 nerez	M6 x 16	2 ks	X90991060160	X90991060160	
32	Plastové pouzdro Pivot 134	Ø 12x27	2 ks	X8D00000000	X8D00000000	

PPS - 80, PPS - 90, PPS - 100



PPS - 80, PPS - 90, PPS - 100

Číslo dílu	Název dílu	Rozměr (mm)	Počet	SIČ / bílá	SIČ / elox	
1	Svislý profil 12217/1 - rohový	1900	1 ks	XVC2170111900	XVC21701X1900	
2	Svislý profil 12215/1 - ke stěně	1900	1 ks	XVC2150111900	XVC21501X1900	
3	Sklo PS rovné (bez děr)	723 x 1900	1 ks pro PPS - 80	X4Z160J007230	X4Z160J007230	
3	Sklo PS rovné (bez děr)	832 x 1900	1 ks pro PPS - 90	X4Z160J008230	X4Z160J008230	
3	Sklo PS rovné (bez děr)	923 x 1900	1 ks pro PPS - 100	X4Z160J009230	X4Z160J009230	
4	Zasklívací profil číslo 90 - svislý	1900	2 ks	X89000000000	X89000000000	
5	Holografické logo RAVAK		1 ks	X21800000001	X21800000001	

PVS1 - 80

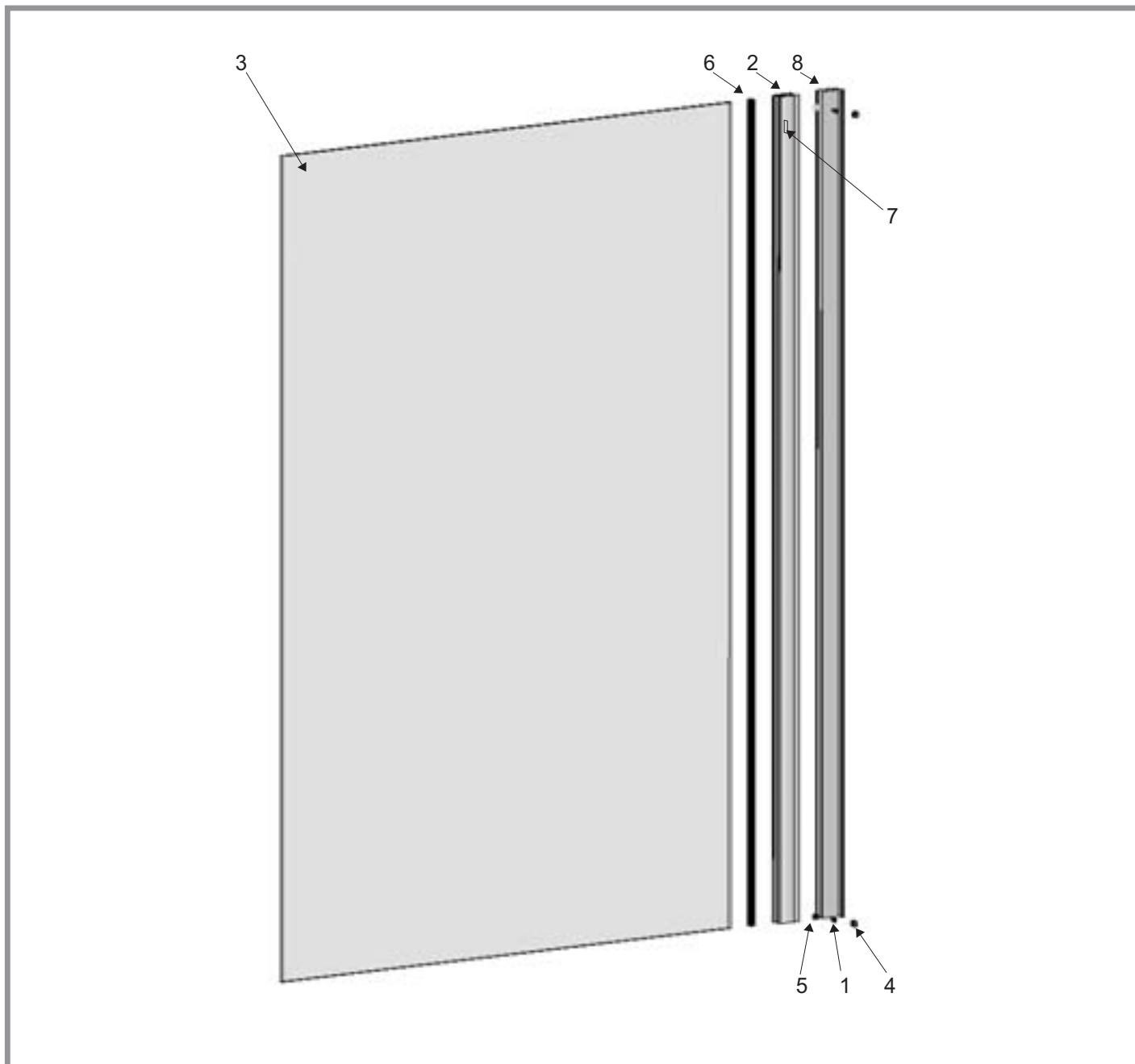

Číslo dílu	Název dílu	Rozměr (mm)	Počet	SIČ / bílá	SIČ / elox	
1	Šroub samořez. nerez	Ø3,5 x 13	2 ks	X97981035130	X97981035130	
2	Svislý profil 12215/02 -ke stěně	1400	1 ks	XVC2150211400	XVC21502X1400	
3	Sklo PS rovné (bez děr)	767 x 1400	1 ks	X4Z160J007230	X4Z160J007230	
4	Krytka 105	Ø11,4 x 5,5	2 ks	X8A500000001	X8A500000001	
5	Podložka krytky 106	Ø10 x 4,5	2 ks	X8A600000000	X8A600000000	
6	Zasklívací profil 111 CB Transparent	1400	1 ks	X8B100000000	X8B100000000	
7	Logo RAVAK		1 ks	X21800000001	X8B100000000	
8	Ustavovací profil 12216/02	1400	1 ks	XWC2160211400	XWC21602X1400	



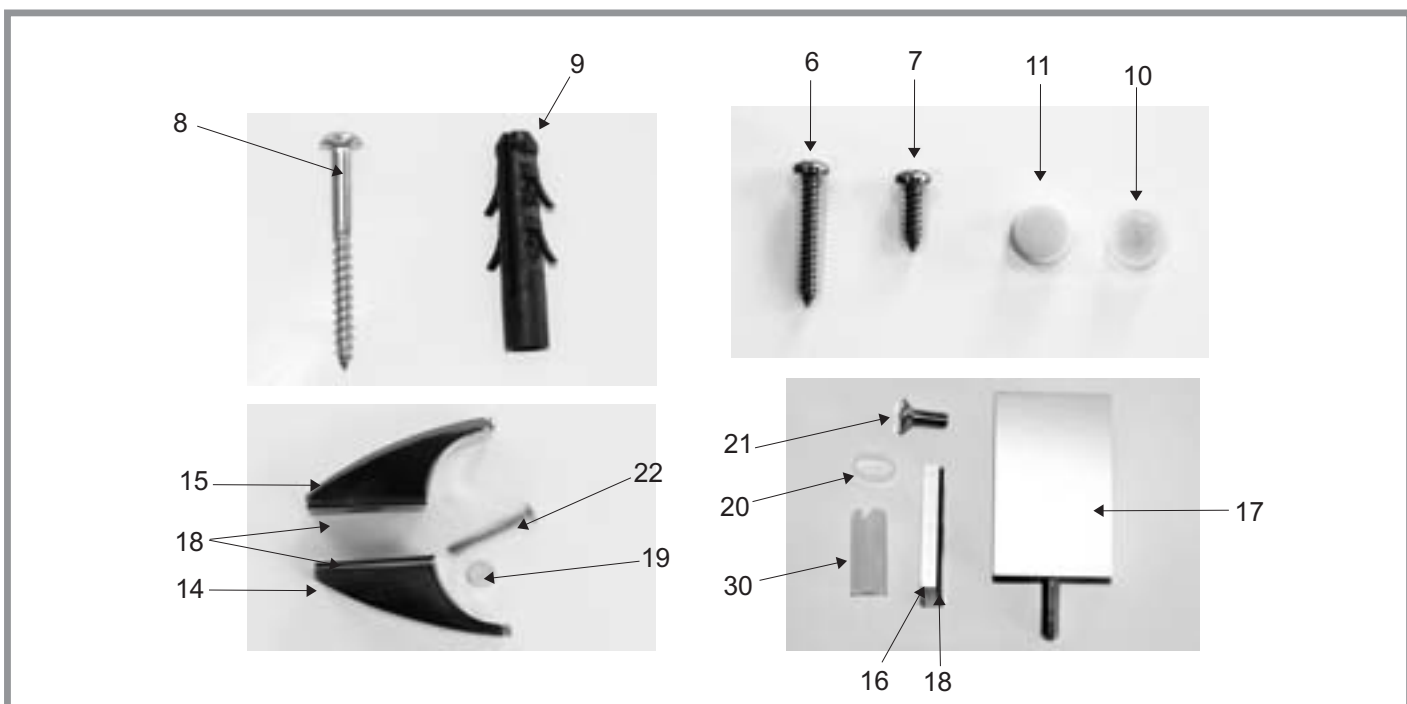
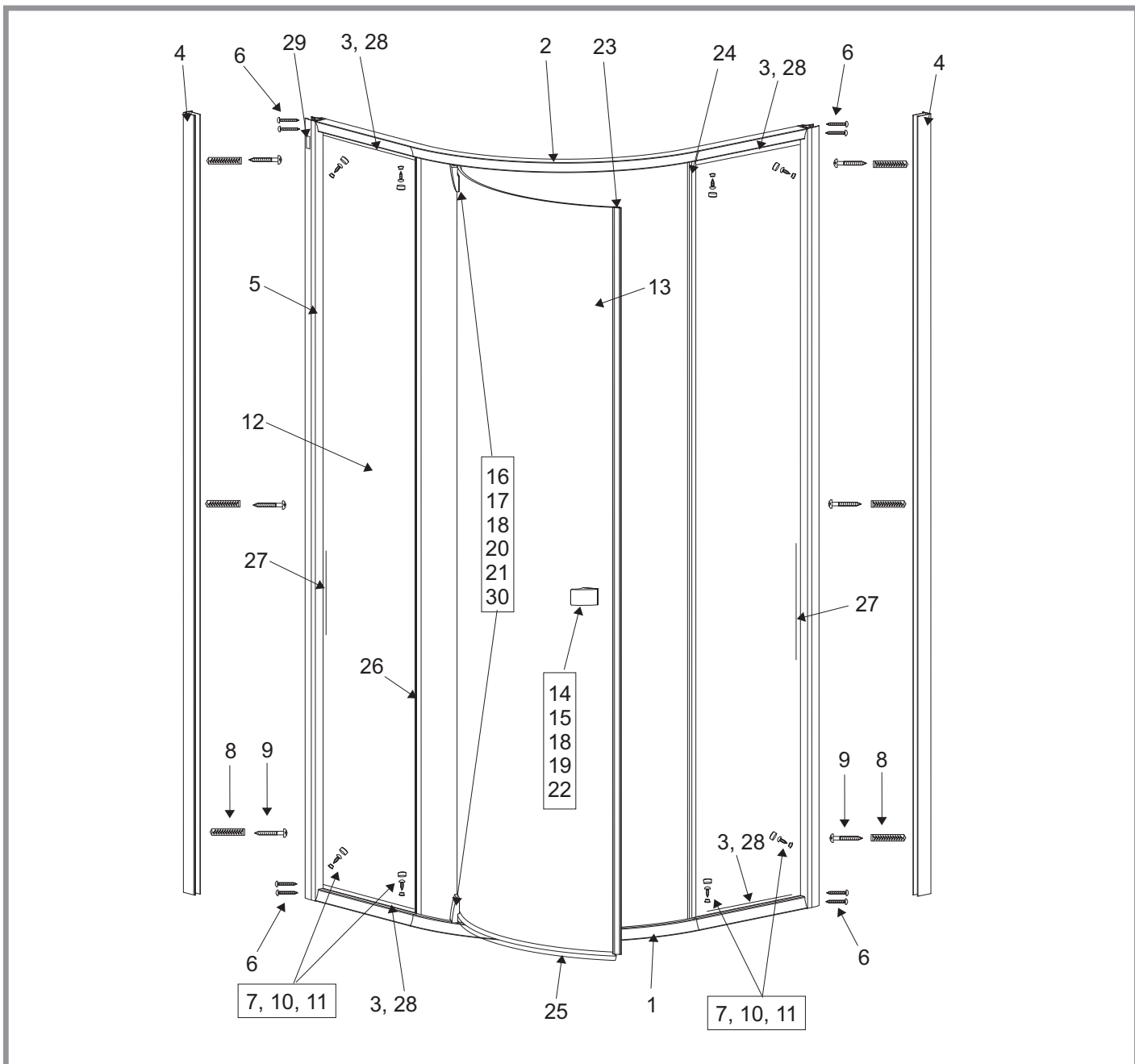



PSKK3 - 80, PSKK3 - 90, PSKK3 - 100







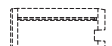

PSKK3 - 80, PSKK3 - 90, PSKK3 - 100





Číslo dílu	Název dílu	Rozměr (mm)	Počet	SIČ / bílá	SIČ / elox	
1	Vodorovný profil pravý 12159/14	1244	1 ks pro PSKK3 - 80	XVC1591411244	XVC15914X1244	
1	Vodorovný profil pravý 12159/15	1444	1 ks pro PSKK3 - 90	XVC1591511444	XVC15915X1444	
1	Vodorovný profil pravý 12159/16	1644	1 ks pro PSKK3 - 100	XVC1591611644	XVC15916X1644	
2	Vodorovný profil pravý 12159/17	1244	1 ks pro PSKK3 - 80	XVC1591711244	XVC15917X1244	
2	Vodorovný profil pravý 12159/18	1444	1 ks pro PSKK3 - 90	XVC1591811444	XVC15918X1444	
2	Vodorovný profil pravý 12159/19	1644	1 ks pro PSKK3 - 100	XVC1591911644	XVC15919X1644	
3	Zasklívací Profil RA-AL-009/53	251	4 ks pro PSKK3 - 80	XVRA095310251	XVRA0953X0251	
3	Zasklívací Profil RA-AL-009/54	351	4 ks pro PSKK3 - 90	XVRA095410351	XVRA0954X0351	
3	Zasklívací Profil RA-AL-009/55	451	4 ks pro PSKK3 - 100	XVRA095510451	XVRA0955X0451	
4	Ustavovací profil 12216/1	1900	2 ks	XVC2160111900	XVC21601X1900	
5	Svislý profil 12213/2 4-otvory	1900	2 ks	XVC2130211900	XVC21302X1900	
6	Šroub samořezný DIN 7981 A2	Ø 3,5 x 25	8 ks	X97981035250	X97981035250	
7	Šroub samořezný DIN 7981 A2	Ø 3,5 x 13	8 ks	X97981035130	X97981035130	
8	Vrut do hmoždinky	Ø 4 x 40	6 ks	X94000040400	X94000040400	
9	Hmoždinka	Ø 8 pro 4 x 40	6 ks	X20600080000	X20600080000	
10	Podložka krytky 106	Ø 10 x 4,5	8 ks	X8A600000000	X8A600000000	
11	Krytka 105 (vrutu 3,5x13)	Ø 11,5 x 6	8 ks	X8A500000001	X8A500000000	
12	Sklo PS rovné	247 x 1870	2 ks pro PSKK3 - 80	X4Z60I702470	X4Z60I702470	
12	Sklo PS rovné	347 x 1870	2 ks pro PSKK3 - 90	X4Z60I703470	X4Z60I703470	
12	Sklo PS rovné	447 x 1870	2 ks pro PSKK3 - 100	X4Z60I704470	X4Z60I704470	
13	Sklo dveří - ohnuté	702 x 1824	1 ks	X4Y60I24702B	X4Y60I24702B	
14	Madlo vnější		1 ks	Bílá X3PVV00700001 Chrom X3PVV0070000A	X3PVV0070000X	
15	Madlo vnitřní		1 ks	Bílá X3PVV00600001 Chrom X3PVV0060000A	X3PVV0060000X	
16	Příložka pantu	38 x 38 x 5	2 ks	Bílá X3PVV01500001 Chrom X3PVV0150000A	X3PVV0150000X	
17	Pant s čepem		2 ks	Bílá X3PVV01600001 Chrom X3PVV0160000A	X3PVV0160000X	
18	Pružná podložka	37 x 37	6 ks	X3PVPR0010000	X3PVPR0010000	
19	Bužírka transparent	Ø 5/7 - 5,5	1 ks	X80001075050	X80001075050	
20	Bužírka transparent	Ø 10/12 - 6	2 ks	X65671500015	X65671500015	
21	Šroub imbusový DIN 7991 nerez	M6 x16	2 ks	X90991060160	X90991060160	







PSKK3 - 80, PSKK3 - 90, PSKK3 - 100

Číslo dílu	Název dílu	Rozměr (mm)	Počet	SIČ / bílá	SIČ / elox	
22	Šroub DIN 964 mm	M4x30	1 ks	X90964040300	X90964040300	
23	Magnet SJ	1824	1 ks	X65622200013	X65622200013	
24	Magnet JS	1870	1 ks	X65623200014	X65623200014	
25	Okapnička	702	1 ks	X65671500017	X65671500017	
26	Lišta praporek	1865	1 ks	X65671500016	X65672500012	
27	Zasklívací profil číslo 90 - svislý	1870	2 ks	X89000000000	X89000000000	
28	Zasklívací profil č. 111 - vodorovný	234	4 ks pro PSKK3 - 80	X8B100000000	X8B100000000	
28	Zasklívací profil č. 111 - vodorovný	334	4 ks pro PSKK3 - 90	X8B100000000	X8B100000000	
28	Zasklívací profil č. 111 - vodorovný	434	4 ks pro PSKK3 - 100	X8B100000000	X8B100000000	
29	Holografické logo RAVAK		1 ks	X21800000001	X21800000001	
30	Plastové pouzdro Pivot 134	Ø 12 x 27	2 ks	X8D400000000	X8D400000000	

Montážní balíček PSKK3				D00000009	D00000009	
8	Vrut do hmoždinky	Ø 4 x 40	6 ks	X94000040400	X94000040400	
9	Hmoždinka	Ø 8 pro 4 x 40	6 ks	X20600080000	X20600080000	

Spojovací materiál PSKK3				D000001051	D000000005	
6	Šroub samořezný DIN 7981 A2	Ø 3,5 x 25	8 ks	X97981035250	X97981035250	
7	Šroub samořezný DIN 7981 A2	Ø 3,5 x 13	8 ks	X97981035130	X97981035130	
10	Podložka krytky 106	Ø 10 x 4,5	8 ks	X8A600000000	X8A600000000	
11	Krytka 105 (vrutu 3,5x13)	Ø 11,5 x 6	8 ks	X8A500000001	X8A500000000	

Montážní set madla				Bílá D000001001 Chrom D00000A002	D00000X001	
14	Madlo vnější		1 ks	Bílá X3PVV00700001 Chrom X3PVV0070000A	X3PVV0070000X	
15	Madlo vnitřní		1 ks	Bílá X3PVV00600001 Chrom X3PVV0060000A	X3PVV0060000X	
18	Pružná podložka	37 x 37	2 ks	X3PVP0010000	X3PVP0010000	
19	Bužírka transparent	Ø 5/7, 5-5	1 ks	X80001075050	X80001075050	
22	Šroub DIN 964 nerez	M4 x 30	1 ks	X90964040300	X90964040300	

Číslo dílu	Název dílu	Rozměr (mm)	Počet	SIČ / bílá	SIČ / elox	
Montážní set pantu				Bílá D000001052 Chrom D00000A003	D00000X002	
16	Příložka pantu	38 x 38 x 5	2 ks	Bílá X3PVV01500001 Chrom X3PVV0150000A	X3PVV0150000A	
17	Pant s čepem		2 ks	Bílá X3PVV01600001 Chrom X3PVV0160000A	X3PVV0160000X	
18	Pružná podložka	37 x 37	4 ks	X3PVPR0010000	X3PVPR0010000	
20	Bužírka transparent	Ø 10/12-6	2 ks	X3G20070000	X3G020070000	
21	Šroub imbusový DIN 7991 nerez	M6 x 16	2 ks	X90991060160	X90991060160	
30	Plastové pouzdro Pivot 134	Ø 12x 5	2 ks	X8D00000000	X8D00000000	

RAVAK a.s., Obecnická 285, 261 01 Příbram I, ČR
tel.: +420 318 427 111, fax: +420 318 427 278, e-mail: info@ravak.cz, web: www.ravak.cz

RAVAK SLOVAKIA spol. s r.o., Einsteinová 11, 851 01 Bratislava
tel.: +421 2 / 444 550 01, fax: +421 2 / 444 550 02, e-mail: obchod@ravak.sk, web: www.ravak.sk

RAVAK POLSKA s.a., Kałęczyn 2B,, ul. Radziejowicka 124, 05-825 Grodzisk Mazowiecki, POLSKA
tel.: 22 / 755 40 30, fax: 22 / 755 43 90, e-mail: info@ravak.pl, web: www.ravak.pl

RAVAK Hungary Kft., 1142 Budapest, Erzsébet királyné útja 125, HUNGARY
tel.: 06 (1) 223 13 15, 06 (1) 223 13 16, fax: 06 (1) 223 13 14, e-mail: info@ravak.hu, web: www.ravak.hu

Ravak Gesellschaft für Sanitärprodukte mbH, Alexanderstrasse 58, D - 45472 Mülheim an der Ruhr
Tel. (0208) 37789-30 Fax. (0208) 37789-55, e-mail: info@ravak.de, web: www.ravak.de

RAVAK a.s., Representative Office in Ukraine, 21 Dniprovska Naberezhna str., 2nd floor, 02081, Kyiv, Ukraine
tel.: 00380 44 2203232, 00380 44 3605200, fax: 00380 44 2204343, e-mail: ravak@ravak.kiev.ua, web: www.ravak.ua

OOO RAVAK ru, ul. Staropetrovskiy pr. 7A, Moskva 125 130,
tel./fax: 007 495 710 82 23, 007 495 450 12 77, e-mail: ravak@inbox.ru, web: www.ravak.com

RAVAK®

RAVAK a.s., Obecnická 285, 261 01 Příbram I
tel.: +420 318 427 200, 318 427 111 fax: +420 318 427 269
e-mail: info@ravak.cz, www.ravak.com

Výrobce si vyhrazuje právo změny ceny, technických parametrů, či dalších skutečností bez předchozího upozornění a nenese odpovědnost za tiskové chyby.