

hansgrohe

- DE** Montageanleitung
- FR** Instructions de montage
- EN** Assembly instructions
- IT** Istruzioni per Installazione
- ES** Instrucciones de montaje
- NL** Handleiding
- DK** Monteringsvejledning
- PT** Manual de Instalação
- PL** Instrukcja montażu
- CS** Montážní návod
- SK** Montážny návod
- ZH** 组装说明
- RU** Инструкция по монтажу
- HU** Szerelési útmutató
- FI** Asennusohje
- SV** Monteringsanvisning
- LT** Montavimo instrukcijos
- HR** Uputstva za instalaciju
- TR** Montaj kılavuzu
- RO** Instrucțiuni de montare
- EL** Οδηγία συναρμολόγησης
- SL** Navodila za montažo
- ET** Paigaldusjuhend
- LV** Montāžas instrukcija
- SR** Uputstvo za montažu
- NO** Montasjeveiledning
- BG** Инструкция за употреба
- SQ** Udhëzime rreth montimit
- AR** تعليمات التجميع
- JP** 施工説明書

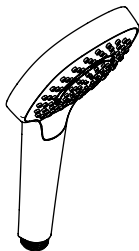
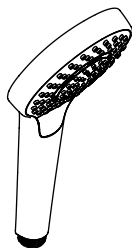

Cromo Select S Multi

26800XXX
26801XXX (9 l/min)

Cromo Select S Vario

26802XXX
26803XXX (9 l/min)

Cromo Select S 1jet

26804XXX
26805XXX (9 l/min)
26806XXX (7 l/min)

Cromo Select E Multi

26810XXX
26811XXX (9 l/min)

Cromo Select E Vario

26812XXX
26813XXX (9 l/min)

Cromo Select E 1jet

26814XXX
26815XXX (9 l/min)
26816XXX (7 l/min)

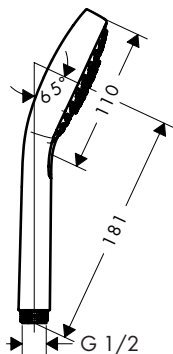
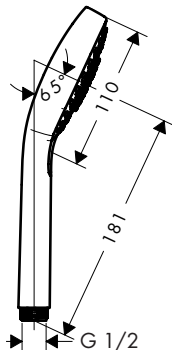

- DE** Reinigungsempfehlung / Garantie / Kontakt
FR Recommandation pour le nettoyage / Garanties / Contact
EN Cleaning recommendation / Warranty / Contact
IT Raccomandazione di pulizia / Garanzia / Contatto
ES Recomendaciones para la limpieza / Garantía / Contacto
NL Aanbevelingen inzake reiniging / Garantie / Contact
DK Rengøringsvejledning / Garanti / Kontakt
PT Recomendações de limpeza / Garantia / Contacto
PL Zalecenie dotyczące pielęgnacji / Gwarancja / Kontakt
CS Doporučení k čištění / Záruka / Kontakt
SK Odporúčania pre čistenie / Záruka / Kontakt
ZH 清洁指南 / 担保 / 接触
RU Рекомендации по очистке / Гарантия / Контакты
FI Puhdistussuositus / Takuu / Kosketus
SV Rengöringsrekommendationer / Garanti / Contacto
LT Valymo rekomendacijos / Garantija / Kontaktai
HR Preporuke za čišćenje / Garancija / Kontakt
TR Temizleme önerisi / Garanti / Temas
 Garanti belgesi ve koşulları için www.hansgrohe.com.tr web sitesini ziyaret ederek; dijital garanti belgenize ulaşabilirsiniz.
RO Recomandări pentru curățare / Garanție / Contact
EL Σύσταση καθαρισμού / Εγγύηση / επαφή
SL Priporočilo za čiščenje / Garancija / Kontakt
ET Puhastussuositused / Garantii / Kontakt
LV Tīrīšanas ieteikumi / Garantija / Kontakti
SR Preporuke za čišćenje / Garancija / Kontakt
NO Anbefaling for rengjøring / Garanti / Kontakt
BG Препоръка за почистване / Гаранция / Контакт
SQ Këshilla rreth pastrimit / Garancia / Kontakt
KO 세정시 권장사항 / 품질보증 / 접촉
AR توصيات التنظيف / الضمان / اتصال
HU Tisztítási tanácsok / Garancia / érintkezés
JP お手入れの方法 / 保証について / ご連絡先



www.hansgrohe.com/cleaning-recommendation

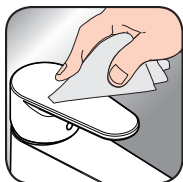

www.hansgrohe.com/cleaning-recommendation



www.hansgrohe.com/cleaning-recommendation



www.hansgrohe.com/cleaning-recommendation

DE Einfach sauber: Kalk lässt sich von den Noppen ganz leicht abrubbeln.

FR La propreté en toute simplicité: les dépôts formés sur les buses élastiques en silicone s'éliminent par un simple passage de la main.

EN Just clean: simply rub over the spray nozzles to remove lime scale.

IT Facile da pulire: Il calcare viene eliminato semplicemente dagli ugelli elastici in silicone.

ES Fácil aseo: La cal se puede retirar sencillamente frotando con los dedos de las toberas elásticas de silicona.

NL Eenvoudig schoon: Kalk kan eenvoudig van de noppen worden gewreven.

DK Enkel rengøring: Det er let at fjerne kalkaflejringer fra stråledyserne.

PT Simplesmente limpo: o calcário pode ser simplesmente retirado das saliências através de fricção.

PL Po prostu czysto: Pęczki można całkiem łatwo oczyścić z kamienia.

CS Jednoduše čistě: Vapenné usazeniny můžete z noplek snadno odstranit otřením.

SK Jednoducho čistý: Vodný kameň sa dá zo štetín celkom ľahko odstrániť.

ZH 清洁: 只需要揉搓花洒表面的出水孔即可去除水垢。

RU Простота чистки: известь очень легко стирается с утолщений.

FI Yksinkertaisesti puhdas: kalkin voi helposti hieroa irti nypystä.

SV Enkelt att göra rent: det är lätt att ta bort kalk från nopporna.

LT Paprasta švara: kalkės lengvai nugrandomos nuo kilpos.

HR Jednostavno čisto: Kamenac se sasvim lako uklanja s izbočina.

RO Pur și simplu curat: Calcarul se îndepărtează ușor de pe noduri prin frecare.

TR Sadece temiz: Kireç, düğümlemlerle kolayca ovalanabilir.

EL Απλά τέλεια καθαριότητα: Τα άλατα μπορούν να αφαιρεθούν με μεγάλη ευκολία από τα στόμια.

SL Preprosto čisto: arpenec se z lahkoto podrgne z vozličkov.

ET Lihtsalt puhas: luoja saab nuppudelt lihtsalt maha hõõruda.

LV Vienkārša tīrīšana: kalkis no izvīzījumiem ir viegli norubināms.

SR Jednostavno čisto: Kamenac se sasvim lako skida sa izbočina.

NO Simpelt ren: Ved å gnikke er det lett å fjerne kalk fra nuppene.

BG Просто чисто: Варовикът лесно може да се изтресе от удебеленията.

SQ Thjesht dhe pastër. Mbetjet gëlqerore mund të hiqen me fërkim të lehtë.

AR إنه سهل التنظيف، حيث يسقط الجير بسهولة شديدة من الأجزاء الناتئة

HU Egyszerűen tiszta: a vízkő egészen könnyen ledörzsölhető a csomókról.

JP 清掃が簡単: カルキは突起部から簡単にこすり落とすことができます。

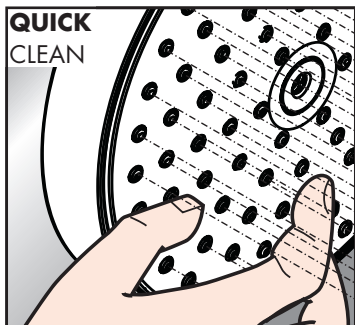

Service

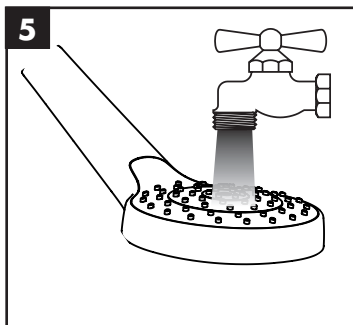
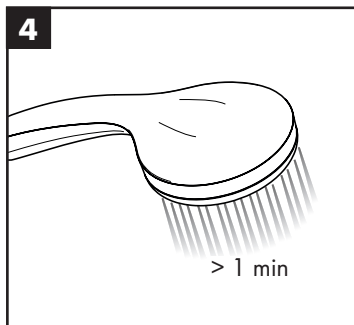
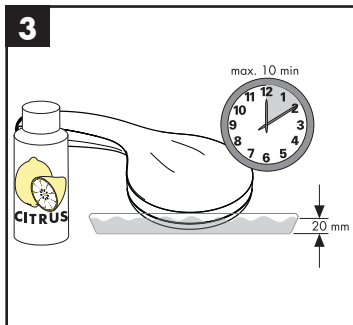
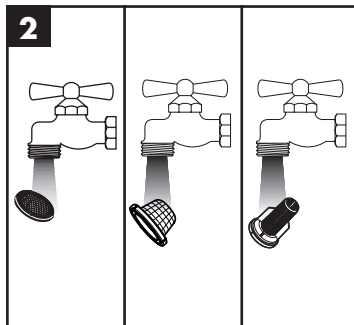
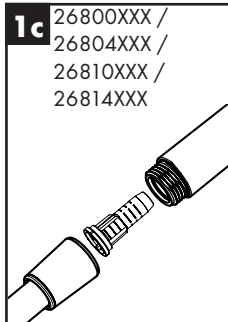
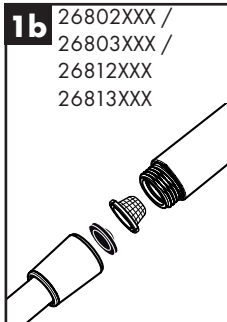
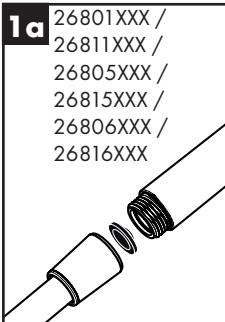

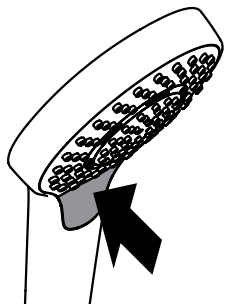

Croma Select S Vario
26803XXX

Croma Select E Vario
26813XXX

Croma Select S Multi
26800XXX

Croma Select S Vario
26802XXX

Croma Select E Multi
26810XXX

Croma Select E Vario
26812XXX

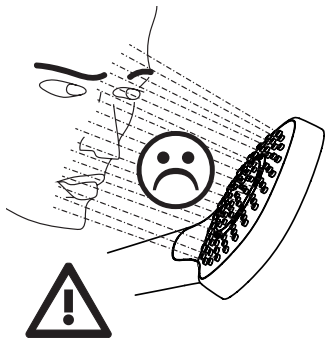

94246000



92672000

98058000
(not included)



5



97708000

98058000
(not included)





P max.
0,6 MPa
6 bar

0,12 - 0,4 MPa
1,2 - 4 bar

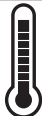

T max.
60 °C

< 50 °C

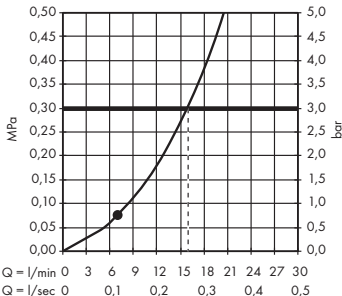

Croma Select S 1jet 26804XXX

Croma Select E 1jet 26814XXX

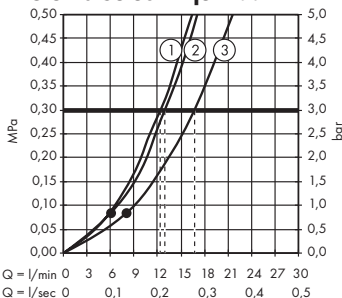

Croma Select S Multi 26800XXX

Croma Select E Multi 26810XXX



TurboRain



IntenseRain



Rain



Massage



IntenseRain



SoftRain



P max.
0,6 MPa
6 bar

0,12 - 0,4 MPa
1,2 - 4 bar

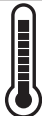

T max.
60 °C

< 50 °C

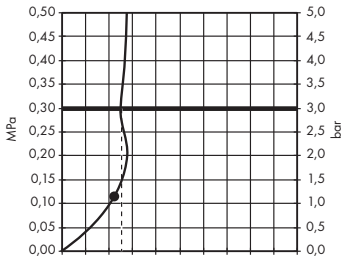

Q = l/min 0 3 6 9 12 15 18 21 24 27 30
Q = l/sec 0 0,1 0,2 0,3 0,4 0,5

Croma Select S 1jet 26805XXX

Croma Select E 1jet 26815XXX

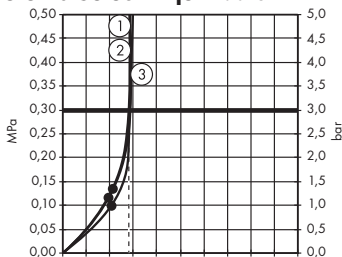

Q = l/min 0 3 6 9 12 15 18 21 24 27 30
Q = l/sec 0 0,1 0,2 0,3 0,4 0,5

Croma Select S Vario 26803XXX

Croma Select E Vario 26813XXX



TurboRain



IntenseRain



Rain



IntenseRain



Massage



SoftRain

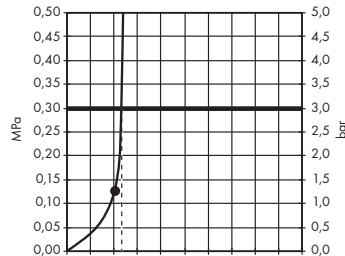

Q = l/min 0 3 6 9 12 15 18 21 24 27 30
Q = l/sec 0 0,1 0,2 0,3 0,4 0,5

Croma Select S 1jet 26806XXX

Croma Select E 1jet 26816XXX

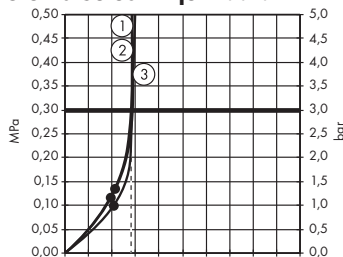

Q = l/min 0 3 6 9 12 15 18 21 24 27 30
Q = l/sec 0 0,1 0,2 0,3 0,4 0,5

Croma Select S Multi 26801XXX

Croma Select E Multi 26811XXX

	P-IX	DVGW	NF
26800XXX	P-IX 28499/IB		X
26802XXX	P-IX 28500/IB		X
26804XXX	P-IX 28501/IB		
26810XXX	P-IX 28502/IB		X
26812XXX	P-IX 28503/IB		X
26814XXX	P-IX 28504/IB		X
26801XXX	P-IX 29820/IZ		
26803XXX	P-IX 29821/IZ		X
26805XXX	P-IX 29822/IZ		
26806XXX	P-IX 29822/IZ		
26811XXX	P-IX 29824/IZ		
26813XXX	P-IX 29825/IZ		X
26815XXX	P-IX 29831/IZ		
26816XXX	P-IX 29826/IZ		

Hansgrohe SE

DIN 4109-1

P-IX 28499/IB

P-IX 28500/IB

P-IX 28501/IB



Hansgrohe SE

DIN 4109-1

P-IX 28502/IB

P-IX 28503/IB

P-IX 28504/IB



Hansgrohe SE

DIN 4109-1

P-IX 29820/IZ

P-IX 29821/IZ

P-IX 29822/IZ



Hansgrohe SE

DIN 4109-1

P-IX 29823/IO

P-IX 29824/IZ

P-IX 29825/IZ



Hansgrohe SE

DIN 4109-1

P-IX 29831/IZ

P-IX 29826/IO



hansgrohe

Hansgrohe · Austraße 5 - 9 · D-77761 Schiltach
 Telefon +49 (0) 78 36/51-1282 · Telefax +49 (0) 7836/511440
 E-Mail: info@hansgrohe.com · Internet: www.hansgrohe.com

03/2022
 9.02429.06 R01